

November, 1974 □ 75 cents

# Electronic Servicing



A HOWARD W. SAMS PUBLICATION



## *Shade-tree technician*

Cassette Workshop

HV Regulator Problems

ES5-1173 R IA 576 6  
TV SPECIALISTS  
915 MAIN ST  
CANON CITY COLO 81222

# PTS ELECTRONICS

## Precision Tuner Service



now available near you

<b>ALABAMA:</b> PTS ELECTRONICS 524 2ND ST. SOUTH BIRMINGHAM, ALA. 35222 TEL. 205. 323-2647	<b>CALIFORNIA—NORTH:</b> PTS ELECTRONICS 4511 ALBURN BLVD. SACRAMENTO, CALIF. 95841 TEL. 916. 482-6220	<b>CALIFORNIA—SOUTH:</b> PTS ELECTRONICS 5111 UNIVERSITY AVE SAN DIEGO, CALIF. 92105 TEL. 714. 280-7070	<b>COLORADO:</b> PTS ELECTRONICS 4958 ALLISON ST. ARVAD, COLO. 80001 TEL. 303. 423-7080	<b>FLORIDA—NORTH:</b> PTS ELECTRONICS 12934 N.W. 7TH AVE. MIAMI, FLA. 33158 TEL. 305. 685-9811	<b>FLORIDA—SOUTH:</b> PTS ELECTRONICS 1918 BLANDING BLVD. JACKSONVILLE, FLA. 32210 TEL. 904. 389-9592	<b>HOME OFFICE—INDIANA:</b> PTS ELECTRONICS 5233 S. HWY. 37 BLOOMINGTON, IND. 47401 TEL. 812. 824-9331	<b>KANSAS:</b> PTS ELECTRONICS 3116 MERRIAM LANE KANSAS CITY, KANSAS 66100 TEL. 913. 831-1222
<b>TEXAS—EAST:</b> PTS ELECTRONICS 4324-26 TELEPHONE RD HOUSTON, TEX. 77032 TEL. 713. 644-6793	<p>..new pts products..                  ..pts l15 dura-seven..stop..seven                  piece alignment tool kit..stop..glass-                  filled polymer plastic for longer life..                  ..stop..up to 10 times the life of regular                  plastic tools..stop                  ..\$2.49..                  ..see your distributor or any                  pts service center..stop..                  ..pts elex..not a                  franchise Co..</p>					<b>LOUISIANA:</b> PTS ELECTRONICS 2914 WITCHWOOD DRIVE METAIRIE, LOUISIANA 70033 TEL. 504. 885-2349	
<b>TEXAS—NORTH:</b> PTS ELECTRONICS MOPAC LANE LONGVIEW, TEX. 75601 TEL. 214. 753-4334						<b>MARYLAND:</b> PTS ELECTRONICS 1105 SPRING ST. SILVER SPRING, MD. 20910 TEL. 301. 565-0025	
<b>TENNESSEE:</b> PTS ELECTRONICS 3614 LAMAR AVE. MEMPHIS, TENN. 38118 TEL. 901. 365-1918						<b>MASSACHUSETTS:</b> PTS ELECTRONICS 191 CHESTNUT ST. SPRINGFIELD, MASS. 01103 TEL. 413. 734-2737	
<b>PENNSYLVANIA—WEST:</b> PTS ELECTRONICS 257 RIVERVIEW AVE. W. PITTSBURGH, PA. 15202 TEL. 412. 761-7646						<b>MICHIGAN:</b> PTS ELECTRONICS 13709 W. EIGHT MILE RD. DETROIT, MICH. 48235 TEL. 313. 862-1783	
<b>PENNSYLVANIA—EAST:</b> PTS ELECTRONICS 1921 S. 70TH ST. PHILADELPHIA, PA. 19142 TEL. 215. 724-0999						<b>MINNESOTA:</b> PTS ELECTRONICS 815 W. LAKE ST. MINNEAPOLIS, MINN. 55408 TEL. 612. 824-2333	
<b>OREGON:</b> PTS ELECTRONICS 5220 N.E. SANDY BLVD. PORTLAND, OREGON 97213 Tel. 503. 282-9636	<b>OKLAHOMA:</b> PTS ELECTRONICS 3007 N. MAY OKLAHOMA CITY, OKLA. 73106 TEL. 405. 947-2013	<b>OHIO—SOUTH:</b> US TUNER SERVICE 8180 VINE ST. CINCINNATI, OHIO 45215 TEL. 513. 821-2298	<b>OHIO:</b> PTS ELECTRONICS 5682 STATE RD. CLEVELAND, OHIO 44134 TEL. 216. 845-8480	<b>NORTH CAROLINA:</b> PTS ELECTRONICS 724 SIEGLE AVE. CHARLOTTE, N.C. 28205 TEL. 704. 332-8007	<b>NEW YORK CITY—</b> <b>NEW JERSEY:</b> PTS ELECTRONICS 158 MARKET ST. E. PATERSON, N.J. 07407 TEL. 201. 791-6380	<b>NEW YORK:</b> PTS ELECTRONICS 993 SYCAMORE ST. BUFFALO, N.Y. 14212 TEL. 716. 891-4935	<b>MISSOURI:</b> PTS ELECTRONICS 8496 PAGE BLVD. ST. LOUIS, MO. 63130

## LET US TAKE CARE OF YOUR TUNER PROBLEMS...

PTS will repair any tuner - no matter how old or new - black & white or color - transistor or tubes - varactor or electronically tuned - detent UHF. 8 hour service is a must!

### ...THIS IS THE SERVICE WE OFFER:

1. Fastest Service—8 hour—in and out the same day. Overnight transit to one of our strategically located plants.
2. Best Quality—Your customers are satisfied and you are not bothered with returning tuners for rework.
3. PTS uses only ORIGINAL PARTS! No homemade or make-do, inferior merchandise (this is why we charge for major parts!). You get your tuner back in ORIGINAL EQUIPMENT condition.
4. PTS is recommended by more TV Manufacturers than any other tuner company.
5. PTS is overhauling more tuners than all other tuner services combined.



Fast **8** hr. Service!

We offer you finer, faster...

...Precision  
Tuner Service

## 1 YEAR GUARANTEE

ELECTRONICS, INC....

...Number ONE and still trying harder!  
(Not a Franchise Company)

VHF, UHF \$10.95  
 UV-COMBO 17.95  
 IF-SUBCHASSIS 12.50  
 Major parts and shipping  
 charged at cost.  
 (Dealer net!)

Over 4000 exact tuner replacements available for \$14.95 up (new or rebuilt).

For More Details Circle (1) on Reply Card

# Now you don't have to turn down jobs just because the sets were made in the Far East.

Your Sylvania Distributor has solved one of your biggest problems in semiconductor replacements for imported equipment.

Until now, unless your shop was around the corner from an import warehouse, you probably had a tough problem. Especially for those non-repairable modules.

But not anymore.

Sylvania's new ECG™ 1000 series gives you over 140 new integrated circuits and modules for imported sets right on your distributor's shelves.

And, thanks to our newest interchangeability guide (ECG 212E-4), those 140 parts add up to a lot more

when it comes to the number of types they'll replace.

That means you don't have to watch a profitable repair job walk out the door just because getting the parts could make it unprofitable.

It also means that you've got one-stop shopping for all of your repair jobs, foreign or domestic.

Whether you need semiconductors, picture tubes or receiving tubes, you'll find them all at one electronic supermarket.

Your Sylvania Distributor.

**GTE SYLVANIA**

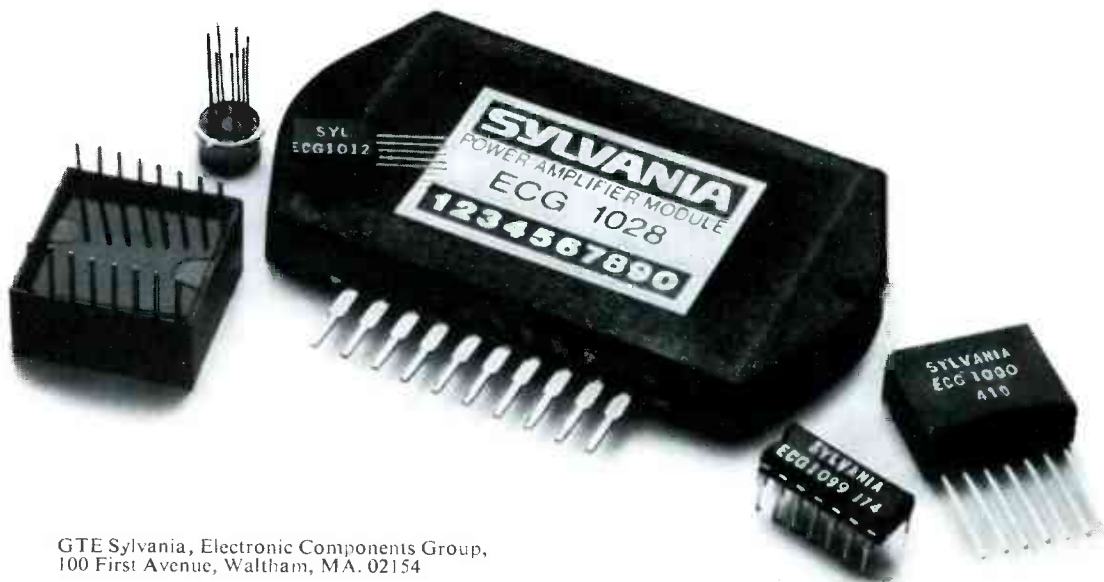

GTE Sylvania, Electronic Components Group,  
100 First Avenue, Waltham, MA. 02154

# Electronic Servicing®

**EDITORIAL**  
RONALD N. MERRELL, Director  
CARL H. BABCOKE, Managing Editor  
JOYCE PRUESSNER, Editorial Assistant  
WEBB G. STREIT, Graphic Designer

**ELECTRONIC SERVICING**  
1014 Wyandotte Street  
Kansas City, Missouri 64105

**TECHNICAL CONSULTANT**  
JOE A. GROVES

**EDITORIAL ADVISORY BOARD**  
LES NELSON, Chairman  
Howard W. Sams & Co., Indianapolis

**CIRCULATION**  
EVELYN ROGERS, Manager

**ADVERTISING SALES**  
Kansas City, Missouri 64105  
Tele: 913/888-4664  
E. P. LANGAN, Director  
R. J. HANCOCK, Manager  
JAKE STOCKWELL  
DENNIS TRIOLA  
GREG GARRISON, Production

**REGIONAL ADVERTISING SALES OFFICES**  
Indianapolis, Indiana 46280  
ROY HENRY  
2469 E. 98th St.  
Tele: 317/846-7026

New York, New York 10017  
STAN OSBORN  
Room 1227  
60 E. 42nd St.  
Tele: 212/687-7240

Mountain View, California 94043  
MIKE KREITER  
2680 Bayshore Frontage Road, Room 102  
Tele: 415/961-0378

London W. C. 2, England  
JOHN ASHCRAFT & CO.  
12 Bear Street  
Leicester Square  
Tele: 930-0525

Amsterdam C. Holland  
JOHN ASHCRAFT & CO.  
W. J. M. Sanders, Mgr.  
for Benelux & Germany  
Herengracht 365  
Tele: 020-240908

Tokyo, Japan  
INTERNATIONAL MEDIA  
REPRESENTATIVES LTD.  
1, Shiba-Kotohiracho, Minatoku  
Tele: 502-0656



**ELECTRONIC SERVICING** (with which is combined PF Reporter) is published monthly by Intertec Publishing Corp., 1014 Wyandotte Street, Kansas City, Missouri 64105.

**Subscription Prices:** 1 year — \$6.00, 2 years — \$10.00, 3 years — \$13.00, in the U.S.A. and its possessions.

All other foreign countries: 1 year — \$7.00, 2 years — \$12.00, 3 years — \$16.00. Single copy 75c; back copies \$1. Adjustment necessitated by subscription termination to single copy rate.



**Robert E. Hertel, Publisher**

Intertec Publishing Corp.  
Subsidiary of Howard W. Sams & Co., Inc.

## in this issue...

**12 Wife To Widow In Five Easy Steps**—common-sense advice in reverse, to keep you healthy—*Joseph Arkin, CPA.*

**13 I'm Just A Shade-Tree Technician At Heart!**—it's possible for test equipment to give you more information than you can handle—*Wayne Lemons.*

**20 Workshop On Cassette Recorders, Part 1**—cleaning and inspection of typical cassette tape machines are detailed in this first part—*Dewey C. Couch, Forest H. Belt Associates.*

**26 Expanding Into CB Service**—installation and servicing of CB radios might be a profitable complement for your TV business—*Leo G. Sands.*

**30 Tracking Down HV Regulator Problems**—symptoms of defects in different types of HV regulator circuits often are not similar—*Robert L. Goodman.*

**40 Reports From The Test Lab**—a unique approach to simplified testing of transistors is found in the Wayne WT2A—*Carl Babcoke.*

### DEPARTMENTS

Electronic Scanner . . . . .4	Audio Systems . . . . .48
Symcure . . . . .8	Antenna Systems . . . . .49
Reader's Exchange . . . . .9	Photofact Bulletin . . . . .50
Troubleshooting Tips . . . . .10	Book Review . . . . .51
Test Equipment . . . . .44	Catalogs and Literature . . . . .53
Product Report . . . . .45	Advertiser's Index . . . . .56

Second class postage paid at Shawnee Mission, Kansas and additional mailing offices. Published monthly at 9221 Quivira Road, Shawnee Mission, Kansas 66215 by Intertec Publishing Corp., 1014 Wyandotte St., Kansas City, Mo. 64105. Send Form 3579 to 9221 Quivira Road, Shawnee Mission, Ks. 66215.

© Copyright, 1974, Howard W. Sams & Co., Inc. All rights reserved. Material may not be reproduced or photocopied in any form without written permission of publisher.

# Introducing the expensive curve tracer that doesn't cost a lot.

The B&K Model 501A.

It's a lab-quality instrument that provides fast analysis of all semiconductors including J-FET's, MOS-FET's, signal and power bipolar transistors, SCR's, UJT's and diodes.

You can test transistors in circuit for GO/NO GO condition. Badly distorted curves will indicate the stage where a defective transistor or other faulty component exists.

The 501A is complete—with scope graticule and FP-3 probe for fast, one-handed in-circuit testing. It generates true current and voltage steps, with 3% accuracy, for measuring beta at all current levels. And it has a sweep up to 100 volts and 100 milliamperes.

With the 501A, curves are displayed on an auxiliary scope screen. And you can hook it up to any scope—old or new.

All three controls can be set in quick-test positions to test and evaluate 90% of all solid-state devices without manufacturer's data sheets.

The 501A won't burn out either the semiconductors or itself.

With all these features, you'd think the 501A was an expensive curve tracer. But look at the price.

For complete technical data, call your B&K distributor. Or write Dynascan Corporation.

**\$163<sup>00</sup>**



Very good equipment  
at a very good price. **B&K**

Product of Dynascan Corporation  
1801 West Belle Plaine Avenue, Chicago, Illinois 60613

**Magnavox Company is resorting to the courts** to get the kind of protection from Japanese television sets it has not been able to get from the U.S. Treasury, reports **Merchandising Week**. Magnavox and Zenith brought the original complaint in 1972, insisting that Tokyo unlawfully helped Japanese electronics firms crack the U.S. market (by handing out export subsidies that are banned by the General Agreement on Tariffs and Trade). Magnavox wants Washington to retaliate with an extra import duty to help wipe out the effects of the Japanese market. So far, the Treasury has failed to act, so Magnavox has filed in the U.S. District Court in Washington, asking that the Customs Bureau be ordered to add the counter-tariff.

**Federal minimum standards for warranties** on all kinds of consumer products, appears certain to become law this year. This legislation also includes expansion of Federal Trade Commission powers over business, which would allow the FTC to police even some local business operations. Federal standards defines a warranty as any undertaking in writing which agrees to refund, repair or replace any product which fails to meet specifications set forth in the sale of the product. The supplier of a warranty must disclose in writing whether the warranty is "full" or "limited". No warranty could be identified as "full" unless it promised repair, replacement, or refund to remedy defects. Any other type of warranty is a "limited" one. **Home Furnishings Daily** also reports that the identity of the supplier and purchaser of the warranty must be established, what the supplier will do to honor the warranty, what the consumer must do to secure fulfillment of the warranty, and what legal remedies are available to a dissatisfied customer.

**Muzak Corporation plans to use satellites** to beam recorded music to thousands of small earth stations, if tests under way prove successful. Four channels, one for each continental U.S. time zone, will be sent to the satellites for broadcast across the country. Receivers atop subscriber buildings will be tuned to one of the channels. A four-foot-diameter antenna, low-noise receiver, and down converter were mounted on a balcony of the Waldorf-Astoria in New York when the system was demonstrated. A signal was beamed to the satellite from RCA's ground station in Valley Forge, Pennsylvania.

**The Anode**, official publication of the Television Service Association of Arkansas, was selected from thirty other publications as the "Outstanding State Association Publication" at the NESDA convention in Hawaii.

**Bert Wolf, who has contributed several articles to Electronic Servicing**, has been named vice-president and general manager of the Distributor Sales Division of Jerrold Electronics Corporation. Wolf, a pioneer in both MATV and CATV, has been with Jerrold for 21 years.



Photo courtesy of Jerrold Electronics.

(Continued on page 6)



INTRODUCING  
AT JUST

**\$39.95**  
WITH  
CABLES

**SUBSTITUNER**  
BY TSC

# TUNER SERVICE CORPORATION

## FEATURES

- A UHF TUNER WITH 70 CHANNELS WHICH ARE DETENTED AND INDICATED JUST LIKE VHF CHANNELS
- A VHF HI-GAIN SOLID STATE TUNER

DEMONSTRATE THE SUBSTITUNER TO YOUR CUSTOMERS AND SHOW IMPROVED RECEPTION WITH THEIR T.V. SETS.

PURCHASE FROM ANY OF THE FOLLOWING TUNER SERVICE CORP. CENTERS.



HEADQUARTERS	BLOOMINGTON, INDIANA 47401	537 S. Walnut Street	Tel. 812-334-0411
ARIZONA	TUCSON, ARIZONA 85713	1528 So. 6th Street, P.O. Box 4534	Tel. 602-791-9243
CALIFORNIA	NORTH HOLLYWOOD, CALIF. 91601	10654 Magnolia Boulevard	Tel. 213-769-2720
	BURLINGAME, CALIF. 94010	1324 Marsten Road	Tel. 415-347-5728
	MODESTO, CALIF. 95351	123 Phoenix Avenue	Tel. 209-521-8051
FLORIDA	TAMPA, FLORIDA 33606	1505 Cypress Street	Tel. 813-253-0324
	HIALEAH, FLORIDA 33016	906 E. 25th Street	Tel. 305-836-7078
GEORGIA	ATLANTA, GEORGIA 30310	938 Gordon Street S.W.	Tel. 404-758-2232
ILLINOIS	CHAMPAIGN, ILLINOIS 61820	405 East University Street	Tel. 217-356-6400
	CHICAGO, ILLINOIS 60621	737 West 55th Street	Tel. 312-873-5556-7
	SKOKIE, ILLINOIS 60076	5110 West Brown Street	Tel. 312-675-0230
INDIANA	HAMMOND/INDIANA 46323	6830 Grand Avenue	Tel. 219-845-2676
	INDIANAPOLIS, INDIANA 46204	112 W. St. Clair St.	Tel. 317-632-3493
KENTUCKY	LOUISVILLE, KENTUCKY 40208	2920 Faylor Boulevard	Tel. 502-634-3334
LOUISIANA	SHREVEPORT, LOUISIANA 71104	3025 Highland Ave.	Tel. 318-861-7745
MARYLAND	BALTIMORE, MD. 21215	5505 Reisterstown Rd., P.O. Box 2624	Tel. 301-358-1186
MISSOURI	ST. LOUIS, MISSOURI 63132	10530 Page Avenue	Tel. 314-429-0633
NEVADA	LAS VEGAS, NEVADA 89102	1412 Western Ave. No. 1	Tel. 702-384-4235
NEW JERSEY	JERSEY CITY, NEW JERSEY 07307	547-49 Tonnele Avenue Hwy 1&9	Tel. 201-792-3730
	FRENTON, NEW JERSEY 08638	901 N. Olden Ave.	Tel. 609-393-0999
OHIO	CINCINNATI, OHIO 45216	7450 Vine Street	Tel. 513-821-5080
	CLEVELAND, OHIO 44109	4525 Pearl Road	Tel. 216-741-2314
OREGON	PORTLAND, OREGON 97210	1732 N.W. 25th Avenue	Tel. 503-222-9059
TENNESSEE	GREENEVILLE, TENNESSEE 37743	1215 Snapps Ferry Road	Tel. 615-639-8451
	MEMPHIS, TENNESSEE 38111	3158 Barron Ave.	Tel. 901-458-2355
TEXAS	DALLAS, TEXAS 75218	11540 Garland Road	Tel. 214-327-8413
VIRGINIA	NORFOLK, VIRGINIA 23513	3295 Santos Street	Tel. 804-855-2518
CANADA	ST. LAURENT, MONTREAL, QUEBEC H4N-2L7	305 Decarie Blvd.	Tel. 514-748-8803
	CALGARY, ALBERTA, T2H-0L1	448-42nd Avenue S.E., P.O. Box 5823 STN "A"	Tel. 403-243-0971

WATCH US  
GROW

FOR INFORMATION ON FRANCHISE, CONTACT HEADQUARTERS

November, 1974

For More Details Circle (6) on Reply Card

[www.americanradiohistory.com](http://www.americanradiohistory.com)

**Marvin Kramer, president of RCA Sales Corporation**, reportedly is scheduled to be elected president of RCA Distributing, according to **Home Furnishings Daily**. Kramer's post reportedly will be abolished, and William E. Boss, vice-chairman of the Sales Corporation, will continue to head that organization. Another change in the company's electronics marketing organization, is the transfer of **Fred Darby**, vice-president of national accounts, to Kansas City, as manager of the RCA Distributing Company branch.

**Greater productivity offers the most direct route** to new and better products, less inflation, and more jobs, RCA Chairman Robert W. Sarnoff told the 30th International Convention of the International Brotherhood of Electrical Workers in Kansas City recently. He said conditions are now ripe for American companies that manufacture goods abroad for sale in the U.S. market, to move their operations back home. "Many formerly attractive foreign operations are now becoming more costly and less efficient than manufacturing at home," said Sarnoff.

**The price tag of \$70 million** for Philco-Ford's domestic and international home electronics business, reportedly was the reason negotiations were terminated between Ford Motor Company and General Telephone & Electronics. According to **Home Furnishings Daily**, the talks ended in early August.

**Zenith Radio Corporation seeks \$900 million in damages**, and a permanent injunction against 21 firms named in violations of U.S. antitrust laws and the Anti-dumping Act of 1916, reports **Home Furnishings Daily**. Twenty Japanese firms plus Motorola, Incorporated, have been charged. Motorola was named as aiding in the alleged conspiracy by selling its television manufacturing operation to Matsushita Electric Industrial earlier this year. Zenith's suit alleges the defendants engaged in unlawful combination in restraint of U.S., foreign, and interstate trade, and in a conspiracy to monopolize such trade.

**North American Philips of Holland is now virtually in control of Magnavox**, according to financial analysts, reports **Home Furnishings Daily**. While 56 percent of Magnavox's outstanding stock has been tendered, (which gives Philips control), Philips needs 80 percent to issue consolidated financial statements and gain various tax advantages. **HFD** reports that Philips, the largest consumer electronics manufacturer in the world, plans to build Magnavox into a dominant factor in the U.S. home electronics business.



WANT COMPLETE INFORMATION ON

# Oneida's BIG NEW LINE OF GLO-BARS®

a registered trademark of Carborundum

## THERMISTOR'S and VDR'S

We've updated our inventory to include the most current numbers for replacing all popular makes.



Send me your latest catalog on GLO-BARS along with prices and name of Oneida Distributor.

Name.....  
Company.....  
Address.....  
City..... State..... Zip.....

**ONEIDA ELECTRONIC MFG., INC.**

P.O. BOX 678 NORTH COTTAGE STREET  
MEADVILLE, PA. 16335  
PHONE 814/336-2125

756-D

For More Details Circle (7) on Reply Card

ELECTRON



"JOE SERVICES PROWL CAR RADIOS."

# DID YOU KNOW HOT DIP GALVANIZING COSTS \$ 0.20 per pound ?



## ROHN's

No. 25G Tower  
Section weights  
40# x 20¢ = \$8.00

Mfg. Cost

## ROHN's

No. 20G Tower  
Section weights  
30# x 20¢ = \$6.00

Mfg. Cost

■ If you are purchasing towers which are not HOT DIP GALVANIZED your cost should be at least \$8.00 or \$6.00 less.

# ROHN® MANUFACTURING

DIVISION OF



P.O. BOX 2000 / PEORIA, ILL. 61601

"Supplying tower needs worldwide for over 25 years."



For More Details Circle (8) on Reply Card

Chassis—Curtis Mathes CMC-51  
PHOTOFACT—1346-1

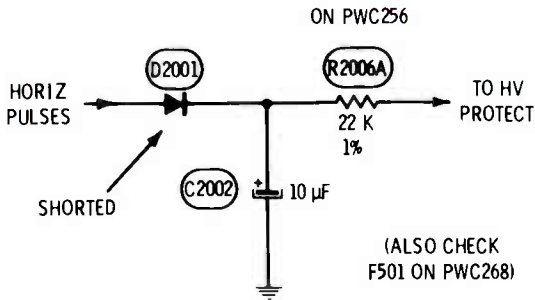

FIG. 1

**Symptom**—Snowy picture, reduced height, and low brightness

**Cure**—Check D2001, and replace if shorted. Also, check fuse F501 and replace if open

Chassis—Curtis Mathes C-51  
PHOTOFACT—1346-1

Remove connector EE3 from power supply module PWC228. Connect a 140-ohm 150W resistor between EE3 and EE4 (ground). Jumper the base of TR603 Error Amp to ground. With line voltage of 120 volts, connect voltmeter from EE3 to ground and adjust VR602 Bias control for a reading of +125 volts. Remove jumper and adjust VR601 Voltage control for +112 volts. Remove test resistor and re-install EE3 connector.

**Symptom**—HV Protect activates falsely (no sound-no raster) with weak signal or between stations

**Cure**—Adjust +112 volt supply, as given

Chassis—Curtis Mathes CMC-51  
PHOTOFACT—1346-1

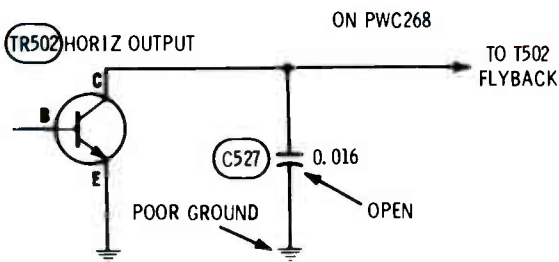
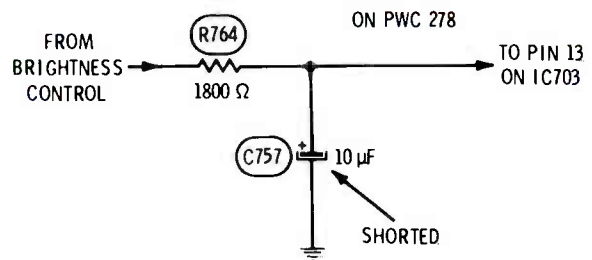

FIG 3

**Symptom**—Horiz output transistor fails periodically

**Cure**—Check C527, and replace if open. Also, check for bad ground at C527

Chassis—Curtis Mathes C-51  
PHOTOFACT—1346-1



**Symptom**—Right half of lines missing in service position

**Cure**—Check C757, and replace if shorted

Chassis—Curtis Mathes C-51  
PHOTOFACT—1346-1

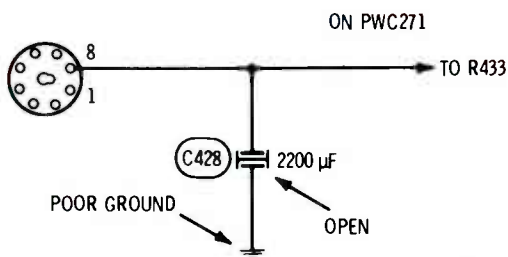

FIG 5

**Symptom**—Reduced height

**Cure**—Check C428, and replace if open

Chassis—Curtis Mathes  
PHOTOFACT—1346-1

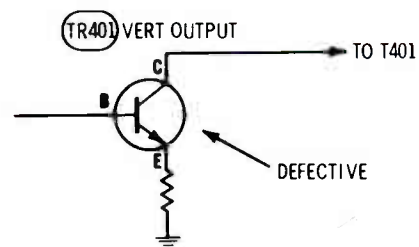

FIG 6

**Symptom**—Compression at bottom of picture

**Cure**—Often caused by a defective TR401 output transistor. JAN code 3-1 and later recommended

# reader's exchange

**Needed:** Schematic and power transformer for a David Bogen amplifier, type RP100BM, series II.

A. V. Burnett  
5721 Melton Drive  
Oklahoma City, Oklahoma 73132

**Needed:** Flyback transformer and focus coil for a RCA CTC16H color TV. RCA part numbers 113992 and 113999, respectively.

E. A. De John  
16134 Westbrook Street  
Detroit, Michigan 48219

**Needed:** Operator's manual with schematic that gives voltages and waveforms for a Squires Sanders model SS-310 closed-circuit TV camera. Will buy or copy and return.

Gerald Koske  
10204 Thayer Road  
RR 1 Ringwood, Illinois 60072

**Needed:** Recent tube charts for the Hickok model 799 tube tester, and the Amphenol CRT Commander model 855 CRT tester and rejuvenator. Chart for Hickok dated 07-01-66. Will buy, or copy and return.

James F. Beckham  
120 Spring Street  
Gaithersburg, Maryland 20760

**Needed:** Instruction book and schematic for a Hickok 0510, AF/RF oscillator. Will buy, or copy and return.

Harold Elwood  
517 Melrose Avenue  
South Plainfield, New Jersey 07080

**Needed:** Instruction manual for Weston Selective Analyzer, model 665.

Henry Rosenblatt  
603 Commonwealth Avenue  
Newton, Massachusetts 02159

**Needed:** Record index size sensor for Sears/Silvertone changer, chassis number 528; numbers on turntable are 34611 and 5-7978K. Also need good used flyback for Philco chassis 18QT85, part number 32-10079-1 294, and IF coil for Philco antique AM-SW radio model 89, code 123. Also source for antique radio parts.

Don Setliff Radio  
Route 1, Box 2902  
Culloden, West Virginia 25510

**Needed:** Schematic, service literature, parts availability, or any information on Westinghouse TG30 C17A audio/visual recorder made by Ikegamic Electronics of Long Island City, New York.

Tom Zwinger  
TZTV  
918 North Concord Street  
South St. Paul, Minnesota 55075

# Speed TV repairs for more profits with GE's 1975 Symptom Repair Manual

The Symptom Repair Manual lists a variety of symptoms for individual GE TV chassis and tells you what to check and in what order. These symptoms and repairs were developed from thousands of service technician invoices and represent the combined experience of hundreds of technicians.



The 70-page manual is 5½" by 8½" and fits neatly in your tool caddy.

Free to subscribers of GE Technical Data, the Symptom Repair Manual is offered to every non-subscribing technician for \$1.00 handling charge (four copies—\$3.00). Effective use of the manual saves time, money and aggravation and helps to build your reputation for fast, reliable service. Send the coupon to order yours today.

"DUTCH" MEYER  
GENERAL ELECTRIC COMPANY  
COLLEGE BOULEVARD  
PORTSMOUTH, VA. 23705

PLEASE CHECK ITEMS DESIRED:

- ONE SYMPTOM REPAIR MANUAL (\$1.00 ENCLOSED)  
 FOUR SYMPTOM REPAIR MANUALS (\$3.00 ENCLOSED)

ENCLOSED IS ( ) CHECK ( ) CASH OR  
( ) MONEY ORDER. (NO C.O.D. PLEASE).

- Please send details on GE Technical Data Subscription Plans which include all updates of the Symptom Repair Manual.

NAME \_\_\_\_\_

SERVICE COMPANY \_\_\_\_\_

ADDRESS \_\_\_\_\_

CITY \_\_\_\_\_ STATE \_\_\_\_\_ ZIP \_\_\_\_\_

We're making it our business  
to make your business easier.

GENERAL  ELECTRIC

# FAST

## COMPLETE SERVICE ON ALL MAKES OF TV TUNERS

Maximum Time In Shop 24 Hrs.

(WE SHIP C.O.D.)  
YOU PAY SHIPPING  
**\$9.95**

(Warranty: One Full Year)

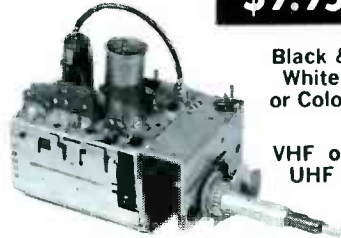

Black & White or Color

VHF or UHF

### UV Combo's \$16.50

Price includes all labor and parts except Tubes, Diodes & Transistors. If combo tuner needs only one unit repaired, disassemble and ship only defective unit. Otherwise there will be a charge for a combo tuner. When sending tuners for repair, remove mounting brackets, knobs, indicator dials, remote fine tuning arrangements and remote control drive units.

## WE UNCONDITIONALLY GUARANTEE All Tuners FOR ONE FULL YEAR



All tuners are serviced by EXPERTLY TRAINED TECHNICIANS with years of experience in this specialized field. All tuners are ALIGNED TO MANUFACTURER'S SPECIFICATION on crystal controlled equipment and air checked on monitor before shipping to assure that tuner is operating properly.

## GEM CITY TUNER SERVICE

Box 6G Dabel Station  
1621 Mardon Drive  
Dayton, Ohio 45420

# troubleshootingtips

Send in your helpful tips—we pay!

### Vertical problem from HV regulator General Electric C-1 chassis (Photofact 1100-2)

The customer complained of insufficient height and poor vertical linearity. When I tried the height and linearity controls, I found almost no effect from the linearity control. The control is supposed to vary the amount of negative voltage at the grid of the vertical-output tube. However, there was no negative voltage at the hot end.

I traced the wiring and components from that point and finally reached the HV regulator circuit which, also, was not operating. Negative voltage from the regulator is used to supply the vertical-linearity control.

After a few ohmmeter tests, I found Y252 diode was open. (Some sets have two in parallel, apparently to lessen the chances of an open diode.)

Replacement of the diode restored the HV regulation and allowed the vertical-linearity control to vary the linearity in the usual way.

G. Hauber  
Raleigh, North Carolina

ness.

Analysis of the grid and cathode voltages of the picture tube suggested that the brightness problem originated in the video circuit. The 6AF9 grid was much too positive, and the voltage changed little from adjustment either of the brightness or the master-brightness controls.

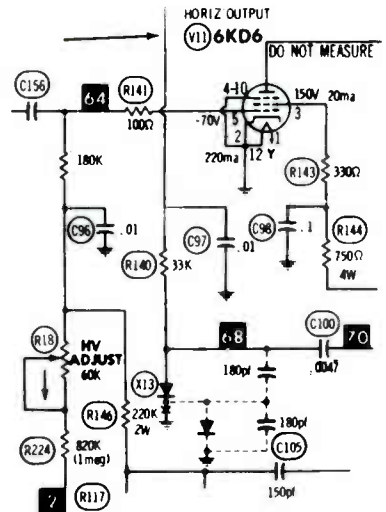

Tracing the circuit, I found the negative voltage for the master brightness was supposed to come from rectification by X13 of horizontal pulses. At first, I presumed this was part of the HV-regulator circuit (as it was in the General Electric problem I described before), but a more careful look at the schematic showed another circuit with VDR R117 was used for HV regulation.

Additional testing in the X13 circuit proved that X13 was shorted, and a new one reduced the brightness to normal.

G. Hauber  
Raleigh, North Carolina

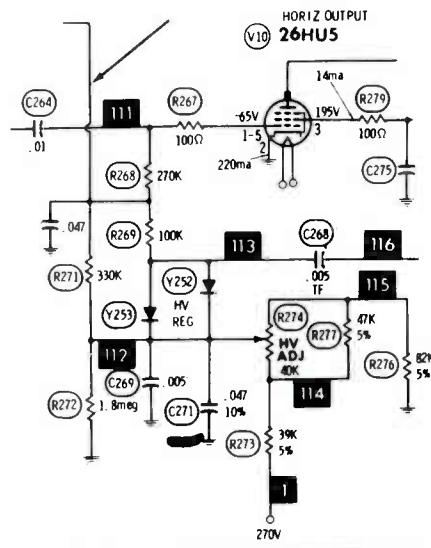

### Brightness problem from HV regulation?

#### Admiral K16 chassis (Photofact 1204-1)

Brightness was excessive, and adjustment of the brightness control made very little change of bright-

### Intermittent picture and sound Zenith 12B8C15 chassis (Photofact 1165-2)

Both picture and sound would be lost after the receiver had been operating for a few minutes. This hinted of a thermal problem, perhaps in one of the transistors.

After the trouble started, I injected a signal at the input of the IF's, using a B&K 1077B. The

signal failed to come through. I went through the IF stages, but still no signal. AGC voltages were a little off, but not enough to cause a total loss of signal.

Much later, I noticed that, when the trouble started, some of the heaters in the series string became darker. Measuring the voltage drop across the heaters, I found an abnormally-high voltage across the heater of V12.

The problem was cured when I resoldered pins 4 and 5 of the V12 socket.

Eugene Meyer  
St. Cloud, New Mexico

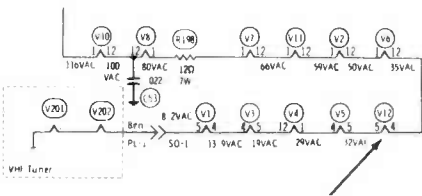

### Overload and vertical lines Sears 562.10481 (Photofact 1107-2)

The symptoms were an overloaded, negative picture with six snivet-type lines on the left edge of the screen. Snow off channel was normal, and reception of weak signals was good.

All AGC voltages checked okay, and bridging the bypasses in the AGC circuit proved fruitless until I tried C128.

Replacement of C128 eliminated all the symptoms.

Edgar B. Hurston, Jr.  
Hartford, Connecticut

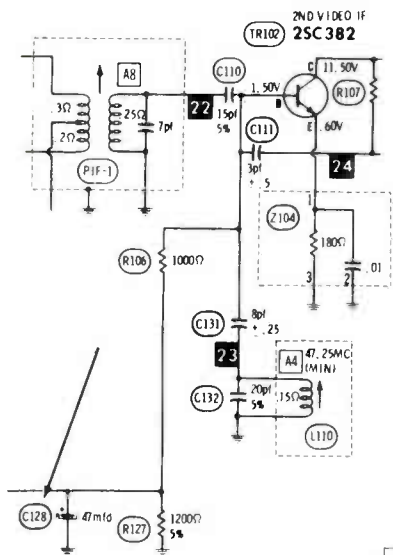

# THE ONLY COLOR SET YOU SHOULD TINKER WITH



It takes more than tools to be a TV service technician. It requires know-how, especially with a color TV set. Some "do-it-yourselfers" actually do more harm than good... and wind up paying more money for repairs or adjustments than they would have if they called their local TV technician at that first sign of trouble. So don't play with that color set. Tinkering can be dangerous as well as expensive. Call your independent TV technician for safety as well as satisfaction.

**THIS MESSAGE WAS PREPARED BY SPRAGUE PRODUCTS COMPANY,  
DISTRIBUTORS' SUPPLY SUBSIDIARY OF SPRAGUE ELECTRIC COMPANY, NORTH ADAMS, MASSACHUSETTS FOR ...  
YOUR INDEPENDENT TV-RADIO SERVICE DEALER**

## PUT THIS BUSINESS-BUILDING TRAFFIC-STOPPER ON YOUR SHOP WALL OR IN YOUR WINDOW

See your Sprague Distributor for window-size blow-ups of this message. Or, send 25¢ to Sprague Products Co., 105 Marshall St., North Adams, Mass. 01247 to cover handling and mailing costs. Just ask for Poster RP-42.

THE BROAD-LINE PRODUCER OF ELECTRONIC PARTS

**SPRAGUE**  
THE MARK OF RELIABILITY

# Wife to widow in five easy steps

By Joseph Arkin

Many businessmen have changed the old adage of "All work and no play makes Jack a dull boy" to read "All work and no play makes jack." We might add that "All work and no play makes Jack's wife likely to become a widow."

If you have not yet applied for membership in the Coronary Club, you can do so (and begin qualifying your wife for the Widow's Auxiliary) by imitating the following characters.

## Workhorse

You should become a workhorse by trying for success in the shortest possible time, and put work ahead of all personal considerations. Stay at the office or shop evenings, Saturdays and holidays. Or, at least take work home with you each night; that's a good way to keep fresh the worries of your working day. Also, stay up late working every night, because too much sleep might dull your senses.

Never say "No" to a request, no matter how "beat" you are, and don't ever delegate responsibility. You're the only one that can be counted on, so carry the ball at all times. Also, it's a poor policy to take a vacation; think of the lost business!

## Weekend Athlete

It's far easier to kill yourself by having a good time than you might realize; especially if you've spent all week doing non-strenuous work. Join the thousands of others rushing to the "happy hunting grounds" by lifting weights, running a mile or two before Sunday breakfast, or by indulging in a fast game of basketball, handball, or touch football with the kids. If you feel that lack of supervised exercise is the reason

for that spare tire around your middle, join a 3-hour calisthenics class at the local gym. But be sure you indulge only on the weekends.

## Jet-Setter

When you travel, make sure you wear yourself to a frazzle. One way is to get up at the crack of dawn, drive to the city for a seminar or a day buying sets or parts, then drive until midnight getting back home, spending those tiring hours to save a few bucks on motel charges. If you should take a vacation, drive

all day and half the night. Then on the last day, take a pill and lots of coffee and drive back home, even if it takes until 7 AM.

## Driver's Education

When you drive, make sure you teach all others a lesson on how to drive. Your motto should be: "I'll teach those dopes!" And don't do it calmly; get mad, roll down your window and shout at them. Pass slow drivers on either side, and cut in so you just barely miss their fenders. That'll show them what's what.

Flip your lights back up to high, if the other driver doesn't dim his lights. Give him a taste of his own medicine. Tailgate if the car up front is traveling a little too slow. After all, **you** can stop on a dime. Always stop for a few quick ones before you go; a few "stiff" drinks could make you the same way.

## Meal-Misser

Another cheap ticket to the Coronary Club is to forget about regular and nutritionally-balanced meals. After all, three regular meals a day are great for kids; but you're a busy man. A restful meal is a waste of time for a man-on-the-go. Think of all the extra work you could get done at the bench or on calls if you don't stop for lunch. Of course, missing meals has a way of making you hungry in between regular mealtimes. So keep plenty of sweets and soft drinks to fool your stomach during the day. Reward a good job by stopping for a malt. And munching a bag of cookies helps ease the frustrations of dealing with a rude customer. Eat too much, drink too much, and smoke too much; those three activities might take you to an early grave, or at least a nice vacation in a hospital nursing a coronary. □





# I'm just a *shade-tree* technician at heart!

By Wayne Lemons

*With tongue in cheek, Wayne illustrates the excellent advice that technicians should always understand the limitations of their test equipment, and not permit it to lead them astray. It's possible for test equipment to give you more information than you can handle!*

Those books and magazines I've been reading are full of new-fangled stuff to test TV's with. They must have finally brain-washed me, because I went to the parts house and put one of those triggered dual-trace scopes on a lay-awake-and-worry-how-to-pay-for-it plan. I figure it will be worthwhile just to dazzle a few of my paying customers and some of my snooty buddies who are in the business.

I suspect, though, that it's kind of like a photographer back home. He had a whole shed full of cameras, flash guns and things like that. I can tell you right now that he got about the same amount of good pictures as the average person would with an Instamatic. But when he has all that high-powered equipment, who's to tell him he doesn't take very good pictures? Not me!

My whole point is that if you're not a good photographer, you won't get any better pictures just because you have a \$1000 camera. And if you're not a good technician, the only thing that'll help you is a gadget my Cousin Lem thought up. His idea was to point the machine at a bad TV set, slide the schematic in a slot, and right away the machine would write out something like: REPLACE C48, A 68 PF CAPACITOR IN THE HORIZONTAL CIRCUIT. CAPACITOR IS BROWN WITH BLUE AND GRAY DOTS. IT IS LOCATED TWO INCHES FROM REAR OF THE CHASSIS AND THREE INCHES FROM RIGHT SIDE OF CHASSIS, LOOKING FROM THE REAR. CAUTION: CAPACITOR LOOKS SOMETHING LIKE A RESISTOR, BUT IS A LITTLE LARGER. DO NOT REPLACE THE WRONG PART! Since it looks like more than a few years before Lem's machine goes into production, we'll just have to use our noggins instead.

Scope showed too much

Maybe I can show you what I mean. The other day I was called from under my shade tree by a couple of friends of mine who are

in the TV repair business up town. They said they had a real hound-dog that was giving them fits, and would I come and get it fixed.

I changed to a clean pair of overalls, and meandered over to their shop. They pointed in the general direction of the chassis, and after I had pushed aside a couple of scopes, a fancy analyzer and other stuff like that, I was able to reach the chassis.

Next, I asked them what the trouble was, and they told me they were sure it was sync trouble and likely was starting in the video stages where the scope showed the signal was sort of jittery and not clean like it ought to be. They also said the dual-trace scope showed the horizontal oscillator and the horizontal sync were not staying exactly in phase. I had sort of figured that out from the picture, because it wasn't holding horizontal too well.

"Whoa, there," I said. "What I want to know is what the fellow who brought it in said was wrong."

That almost threw them for a loop, but after a bit they recalled that the fellow said when he first turned on the set every time, the picture tube didn't light up. But he found out it would light up if he

fiddled with the horizontal-hold control. Also, the hold was awful touchy and hard to keep the picture from jittering back and forth.

I asked what they had done so far. They told me that on their scopes the video signal was okay coming into the grid of the video amplifier, but that it didn't look too good at the plate. It seemed to them the sync pulses didn't stick

out far enough above the video, and there was trash that oughtn't be there.

"Have you tried to set up the oscillator like the manufacturer says to do?" I meant the way of grounding the grid of the sync tube, shorting out the ringing (stabilizing) coil, and adjusting the horizontal hold control until the picture "floats" by. They had tried that,

they said, but it hadn't acted quite right. They figured it was because of the sync problem. And besides, they had replaced the 3-legged phase-detector diode and the oscillator tube 2 or 3 times.

"It's got us kind of buffaloeed," they admitted. "What do you think is wrong?"

"Well, I hate to be contrary, but I don't think you've got video amplifier, AGC, or even sync trouble."

"Why not?"

"I've been looking at the picture, and it's holding vertically tight as a drum. You can see on the schematic (Figure 1) that the vertical and horizontal sync both are taken off the same plate of the sync tube. Judging from that, and from the fact the fellow who owns the set seemed to have trouble with the horizontal oscillator, I figure we'll find the trouble there."

"Want to use one of these scopes?" they asked.

I looked at the schematic. It showed +3.5 volts at the pin-2 control grid. And since it is here that this kind of trouble often hides, I said, "I'd rather have a VTVM."

"We traded ours in on a new automatic ranging and polarity digital voltmeter."

"I guess that'll do," I said.

At pin 2, the voltage was about +9 and flickering up and down. This was more than twice what it should have been. I wondered why. Maybe one of the diodes in the phase detector was bad. I took a clip lead and shorted the center lead of the diodes to ground. The voltage at pin 2 went nearly to zero, and the horizontal oscillator stopped working. But that still didn't prove a diode was bad, because the sync was grounded out, too.

I took my dikes and clipped loose the two leads of the diodes that weren't grounded, and looked at the meter which was still connected to pin 2. The digits were jumping, but the average was about +9. I soldered the two leads back.

After another look at the circuit, I knew there was no way for a positive voltage to be there, unless a capacitor was leaking. There were only two capacitors that could do it. One was a .001 feeding the sampling pulse back to the diodes. The

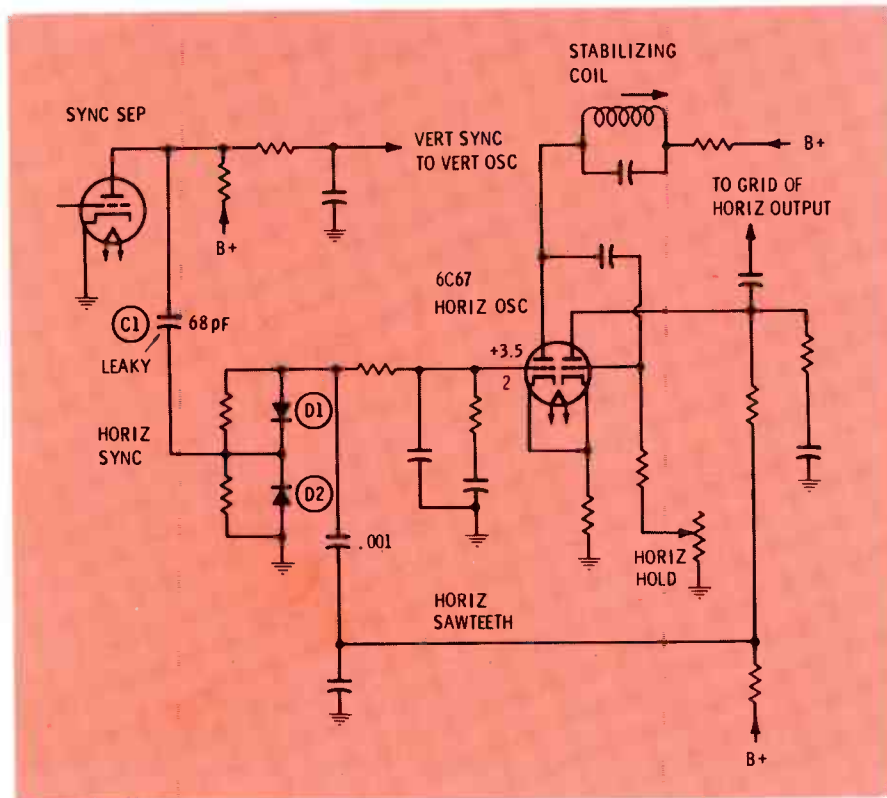

Fig. 1 Simplified schematic of the horizontal AFC and oscillator with the leaky capacitor that gave symptoms of a video trouble.

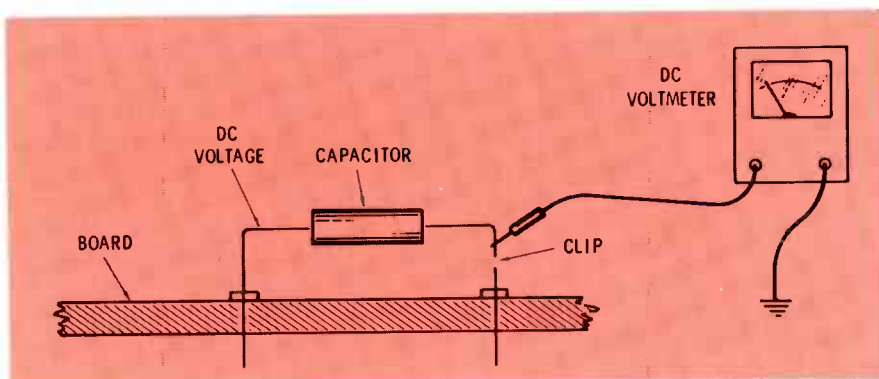

Fig. 2 This method of testing a capacitor for leakage has two advantages besides simplicity. Leakage is tested at approximately the working voltage in the set, and the test is very sensitive (too sensitive to be used with electrolytics). For an accurate reading of the leakage in ohms, use the formula: voltage across capacitor divided by voltage across meter equals leakage resistance of capacitor divided by meter resistance.



other was the 68 pF that feeds the horizontal sync pulses to the phase detector diodes.

In my experience I've found that small capacitors don't leak as often as bigger ones. So, I took my dikes and clipped the lead of the .001 where it fastened to the diodes. The voltmeter on pin 2 kept right on reading positive just about the same as it was. Next, I clipped the lead from the 68 pF at the center pin of the diodes. Sure enough, the reading dropped to nearly zero.

Just to make sure I had found the trouble, I touched the voltmeter probe to the lead of the 68 pF capacitor I had clipped. This time the digits spelled out +31 volts. Hardly any doubt now; the 68 pF capacitor was the one upsetting the horizontal circuit.

I hooked up the .001, put in a new 68 pF capacitor, set up the horizontal stabilizing coil the way I mentioned before, and the picture locked in solid as a brick.

#### Advice

The reason I'm writing this story is to point out that us shade-tree technicians aren't so uptight about all that design jazz we read about so much. We figure it should have been taken care of before the set was built and sold.

By and large, I figure my job is to look at the picture tube, or listen to the sound, and see if I can tell what's wrong (or at least where the trouble might be). I try to remember that a voltmeter's still a mighty nice tool to have if there is no DC voltage, or if it's too high or too low. (I kind of hate to admit it, but those digital voltmeters are mighty nice.)

And another thing, nobody has ever hit on anything better to find a leaky capacitor than a pair of dikes and a voltmeter. Just find which end has the highest voltage, clip the **other lead** loose from the circuit, and touch the voltmeter probe to the loose end of the capacitor. A good capacitor will make the pointer flip and drop to zero.

**Editor's Note:** If your VTVM, FET meter or DMM has around 10 megohms resistance on DC voltage ranges, a capacitor leakage of 10 megohms will cause at the cut end

*about half the reading at the hot end. Or, a leakage of 100 megohms will produce about 10%. In fact, the test is so sensitive that most paper or Mylar types will give some indication, even when new and "perfect". If the leakage is no more than about 2% of the applied voltage, a capacitor probably has low enough leakage for use in almost any circuit. The test won't work with electrolytic types. They read as though shorted.*

By the way, I'm not knocking scopes, not by a long shot. They're good as signal tracers, for measuring frequency response and wave-shapes, and all that. But you got to watch out that they don't show you more than you can figure out (at least until after you find the trouble).

For instance, in this case I told you about, the horizontal circuit was all on edge, shaky and wobbly. So, a lot of the circuits were trying to face up to the problem and hold the picture steady, but the sick horizontal circuit sent out a lot of disturbance to the other circuits so they didn't exactly appear healthy either.

This means you might get some confusing pictures on your scope that could lead you away from the real trouble.

It's like my granddaddy used to say, "Sonny, if you're walking home on a dark night, you'd best stay on the main road and don't take off on what looks like an inviting shortcut, because you are liable to end up in a swamp over your head in alligators!" I swear, that's what my granddaddy used to say. Of course, he came up here to the Ozark Mountains from down south someplace.

**Editor's Note:** Those of us personally acquainted with Wayne Lemons know he is a sharp technician who appreciates the newest and best in test equipment. But his point is a good one; choose the test instrument that will give you an answer without steering you into a time-consuming detour among those "alligators". □

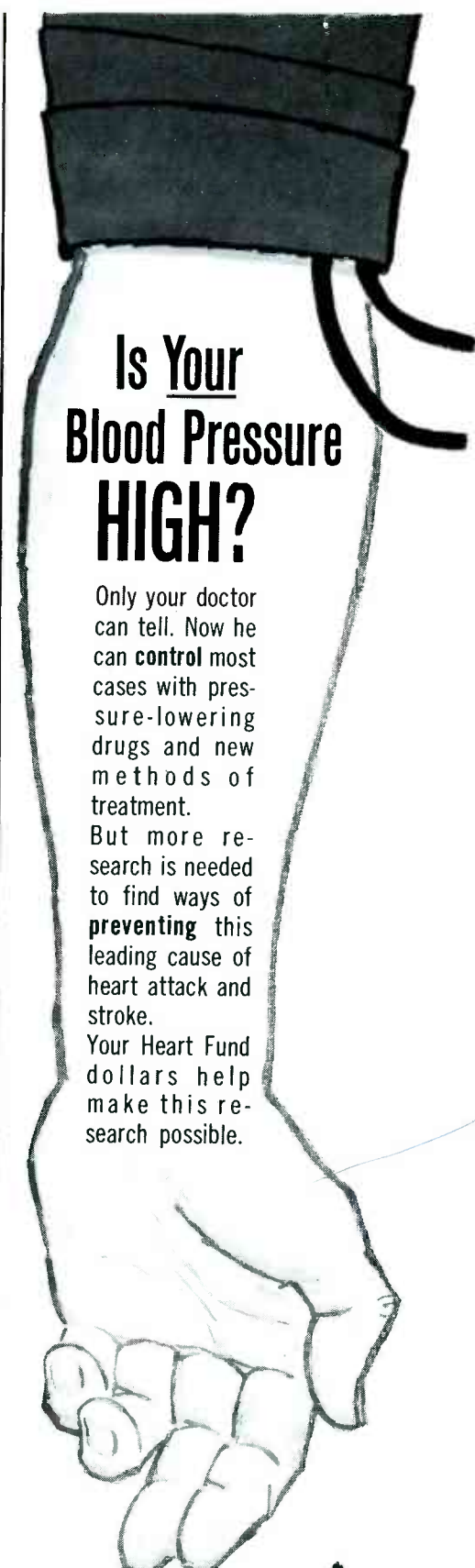

## Is Your Blood Pressure HIGH?

Only your doctor can tell. Now he can **control** most cases with pressure-lowering drugs and new methods of treatment. But more research is needed to find ways of **preventing** this leading cause of heart attack and stroke.

Your Heart Fund dollars help make this research possible.

**GIVE...**  
so more will live  
**HEART FUND**



Contributed by the Publisher

# Telematic

MJ-195

## MASTER TEST RIG FOR TUBE AND SOLID STATE SERVICING



**\$149.95**  
less 19" picture tube

- 30 KV CAPACITY
- METAL CABINET
- SPEAKER BUILT IN
- HIGH VOLTAGE METER
- STATIC CONVERGENCE
- FRONT PANEL CONNECTIONS

# Telematic

2245 Pitkin Ave., Brooklyn, N.Y. 11207

FREE! Adaptor Quick Reference Chart

For More Details Circle (28) on Reply Card

# Can anyone do what you do any better?

You're pretty darn good at your job.  
But today, we all have to  
consider how we can do our work a  
little better. That's how  
each of us can help keep our jobs  
here in America. For now  
and for the future.

## America. It only works as well as we do.

The National Commission on  Productivity, Washington, D.C.



A Public Service of  
This Magazine &  
The Advertising Council

# New generation Flat rate pricing...

...truly outdates old methods ... prices your work realistically!

Still using the old single flat rate charge for house calls or bench work regardless of repair time required? You may say it all averages out. But, how strongly do your customers feel about consumerism and TV exposes? You could be leaving yourself wide open for trouble...big trouble!

This is where **Tech's Guide to Pricing** comes in ... the "New Generation" of flat rate pricing ... the system that breaks down each repair step or adjustment encountered. Keeps a true and proper balance between cost and work performed in the eyes of the consumer.

**Tech's Guide** is in a professional, hard-use cover, 6-ring steel binding, fast-tab design, 7 1/2 x 9 1/2 size fits in the tool box ... ready for immediate use. Calculator adjusts in seconds for any area in the U.S. ... it's the new industry standard. Relieves you of the stress and pressure of pricing responsibility! Simply fill out the coupon, include check or money order. All orders filled same day.

**sperry tech inc.**  
P.O. Box 5234  
Lincoln, NE. 68505

More information please.

My check or money order enclosed.

NAME \_\_\_\_\_

COMPANY \_\_\_\_\_

ADDRESS \_\_\_\_\_

CITY \_\_\_\_\_ STATE \_\_\_\_\_ ZIP \_\_\_\_\_

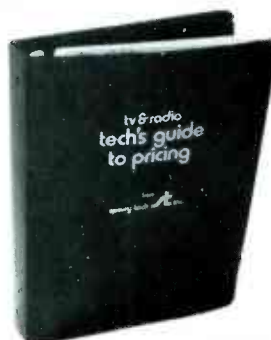

**\$18.00**  
per issue,  
postpaid.

(Nebr. residents add city and state sales tax)



## tv & radio tech's guide to pricing

KIT OR ASSEMBLED...

# HEATH'S NEW "4510" SCOPE

offers features that can't be found on any scope in its price range

- Complete dual trace capability
- DC-15 MHz bandwidth
- Post-deflection accelerated CRT
- Vertical amplifier delay lines
  - Only \$549.95\* kit, \$750.00\* assembled

Our 4510 is the oscilloscope you need to help turn those service problems into profits. It offers a low price plus DC-15 MHz bandwidth, vertical sensitivity of 1 mV/cm, time base sweep to 100 nsec/cm and complete dual trace capability. And it has many features that just can't be found on other scopes in its price range.

**Vertical input sensitivity of 1 millivolt** — over the full DC to 15 MHz bandwidth. With the 4510 and a X10 probe (the way you're most likely to use an oscilloscope) you can read waveforms to 10 mV/cm, not the 50 or 100 mV/cm found on other scopes.

**A post-deflection accelerated CRT** gives a brighter trace with faster writing speeds. Many input signals that wouldn't ordinarily be visible on a mono-accelerated CRT are presented in a sharp, bright trace on the 4510.

**Trigger bandwidth** is guaranteed to 30 MHz with typical triggering capability up to 45 MHz. The digitally-controlled triggering circuits require no stability control. In the automatic mode, a reference baseline is generated even when the trigger signal is absent. Complete triggering controls are provided with choice of AC or DC coupling, triggering at any point on the vertical signal. Choice of automatic or normal sweep uses any one of 22 time bases from 0.2 sec/cm to 0.1  $\mu$ sec/cm.

**Internal delay lines** for the vertical amplifier allow display of at least 20 nanoseconds of the pretriggered waveform, insuring that the complete waveform will be displayed.



**Easy servicing** is assured with all major circuitry located on five circuit boards for easy trouble-shooting. Push-on connectors permit fast removal of any board. Even the CRT can be removed and replaced in a matter of minutes.

Heath engineers are specialists in knowing how to provide good instrument value at a practical price. The 4510 was designed for a maximum of performance at the lowest possible cost. Compare it with the competition. For lab or bench, you won't find a better value.

Send for your free  
Heath catalogs  
today.



The latest Heath/Schlumberger Assembled Instruments Catalog features a complete line of high performance, low cost instruments for industrial and educational applications. Our '75 Heathkit Catalog describes the world's largest selection of electronic kits—including a full line of lab and service instruments. Send for your free copies.

HEATH COMPANY  
Dept. 25-11  
Benton Harbor, Michigan 49022

HEATH  
**Schlumberger**

- Please send the 1975 Heathkit Catalog.  
 Please send the latest Heath/Schlumberger Assembled Instruments Catalog.

Name \_\_\_\_\_

Title \_\_\_\_\_

Company/Institution \_\_\_\_\_

Street \_\_\_\_\_

City \_\_\_\_\_ State \_\_\_\_\_ Zip \_\_\_\_\_

\*Mail order prices; F.O.B. factory.  
Prices & specifications subject to change without notice.

TE-312

For More Details Circle (11) on Reply Card

Forest H. Belt's

# Workshop on cassette recorders Part 1

By Dewey C. Couch

Millions of cassette tape machines are sold in this country each year. New technological advances in magnetic tapes (and in the machines themselves) now make possible true Hi-Fi reproduction from the more sophisticated models. Others that have less fidelity fulfill a variety of purposes. Yes, cassette servicing has become a big business. You, too, can earn handsome profits in this branch of home-entertainment electronics.

Troubleshooting cassette mechanisms might seem complex. Sometimes it's hard to see how all those idlers, levers, and slides work together. Yet, you can make servicing cassettes simple. All you need is a logical approach that adapts to any cassette mechanism.

As we've pointed out in other Workshops, you can't ordinarily conceive the whole job in one step. Seasoned technicians divide mechanical servicing into five stages: **cleaning, inspection, testing, adjustment, and diagnosis.** This first session in the *Cassette Workshop* series elaborates the first two stages. You see the techniques of thorough cleaning and lubrication used by experienced techs. Many cassette troubles are eliminated during the cleaning process, without further testing. Others are found during visual inspection.

Session 2 shows and explains how adjusting, testing, and diagnosis track down all remaining faults, even those you didn't know about. Then, to strengthen your self-confidence in dealing with cassettes, Sessions 3 and 4 detail the workings of today's popular cassette mechanisms.

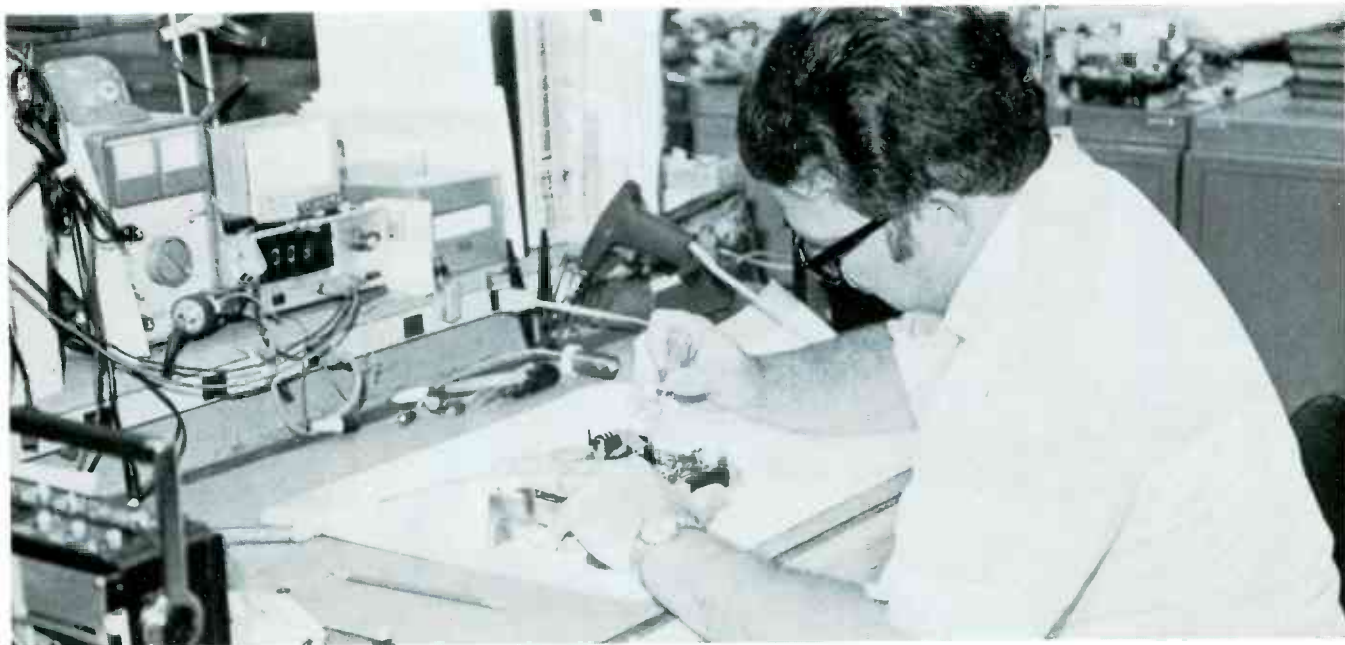

**Step 1.** Before you can service a cassette, you must remove the mechanism from its cabinet. Cassette mechanisms are mounted to their cases in a variety of ways. In most portables, screws hold them to the top cover (or control panel) from beneath. You have to remove the bottom cover first. Don't try to force it. If it doesn't slip off easily after you've removed all visible mounting screws, hunt for hidden screws in the battery and accessory compartments (or under a warranty-seal label).



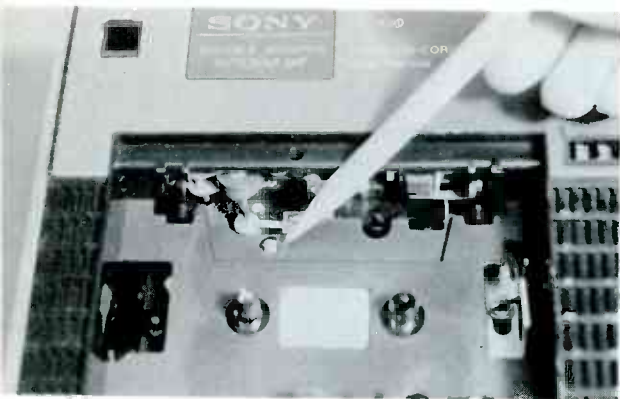

**Step 2.** Remove all knobs. Most are push-on types, but watch for set screws anyway, just to be sure. With portable models, you might have to take the handle off, too. Usually the screws that hold mechanisms to the cabinet are colored. **Be careful not to loosen any screws that might hold mechanism assemblies in place.** Look for hidden screws in the cassette well. When you're sure all mounting screws have been removed, carefully lift the mechanism free. Don't strain any wires that might connect the works to cabinet-mounted parts such as jacks, speakers, etc.

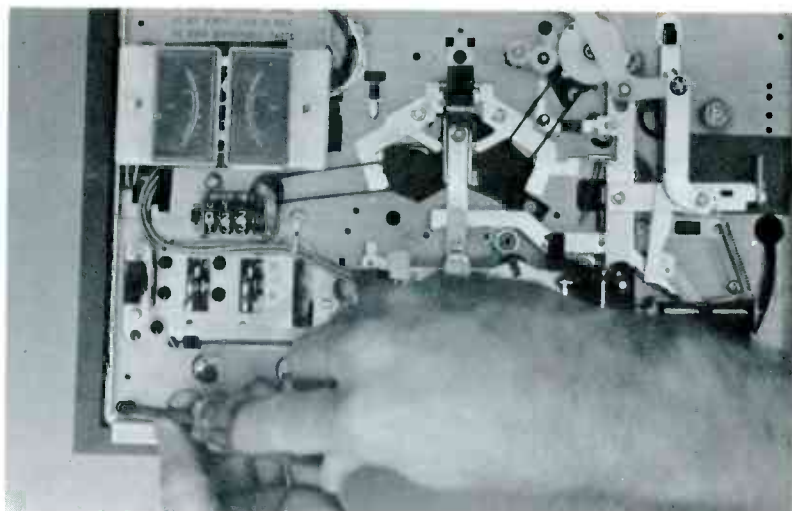

**Step 3.** With many cassette decks, you have to take the control panel off to get at the mounting screws. Expect one screw in each corner. Remove all screws that hold the top control panel, and remove all knobs. You might find screws in the cassette well, too. Once the panel is loose, lift it up and over any projecting parts, such as control shafts or levers. Don't bend or force the cover. Most are plastic and break easily.

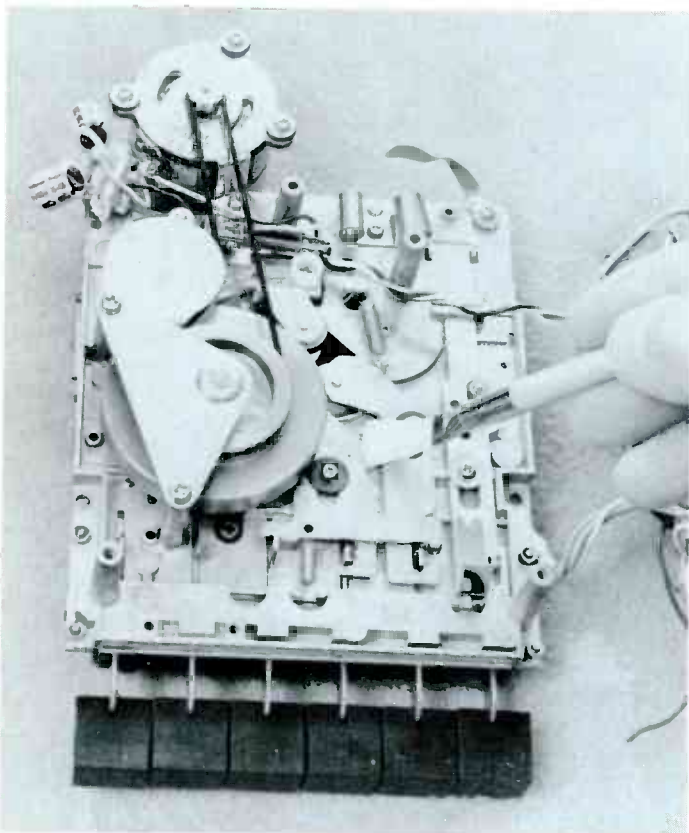

**Step 4.** Dust and lint collect on mechanical parts. Use a clean, soft-bristle brush to whisk away any loose grime clinging to parts and assemblies. Take care not to break any wires or knock any springs loose.

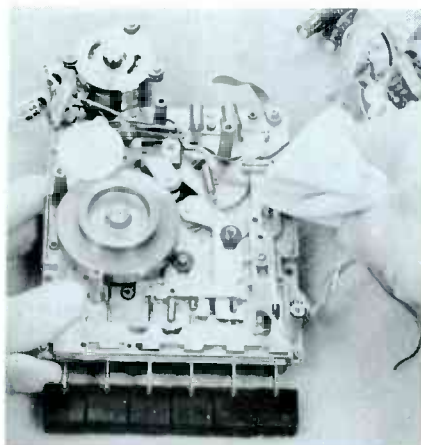

**Step 5.** Clean the baseplate, above and below, of any stuck dirt or old lubricant. Use a clean cloth and alcohol; isopropyl or rubbing alcohol is fine. The alcohol will loosen any caked lubricant that could hinder normal movement of parts or controls. Don't do any lubricating at this stage of servicing.

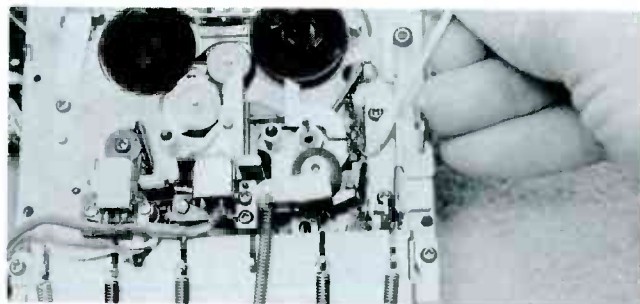

**Step 6.** Lubricants tend to hold dirt and build up accumulations on certain slides and levers. Evaporation then causes the mess to harden. Never use a metal tool, such as a screwdriver, to scratch the caked lubricant loose. You might score or warp the slide. That could cause excessive wear or binding. Try scraping with a small piece of wood or plastic (flat toothpicks or ice-cream sticks are handy for this). After you have cleaned the slides and levers of caked lubricant, use a Q-Tip or cotton ball soaked in alcohol to finish the job.

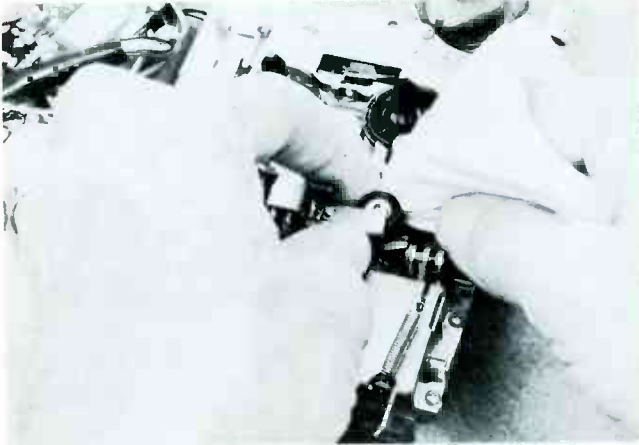

**Step 7.** Oxide particles from the tape collect on the rubber pressure roller. This deposit sometimes causes tape slippage. Use a fresh cloth and alcohol for cleaning here, too. If it's convenient, remove the pressure roller and soak it in alcohol for several minutes. Then wipe it dry with a clean cloth. Repeat the cleaning and drying several times.

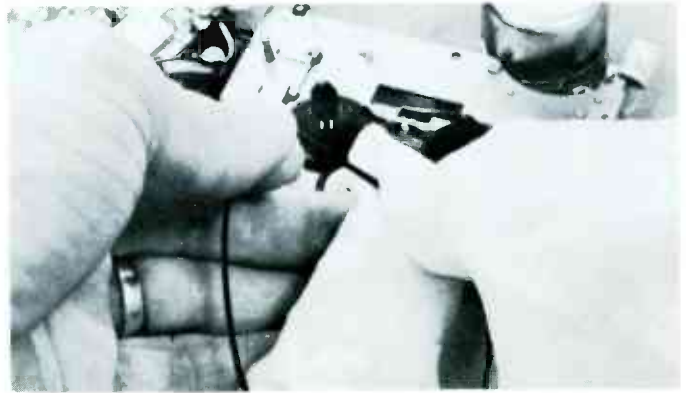

**Step 8.** Lubricants sometimes migrate and contaminate rubber belts and idlers. The result: slippage in the drive train, causing the "wow" sound in playbacks. Most belts come off easily. Remove them and use a clean cloth and alcohol to rid them of all lubricant and other foreign matter. Afterward, avoid touching with your fingers any rubber belts or drive surfaces. Even though your hands may be clean, the minute amount of body oil on your fingertips might contaminate drive parts enough to cause slippage at a later time.

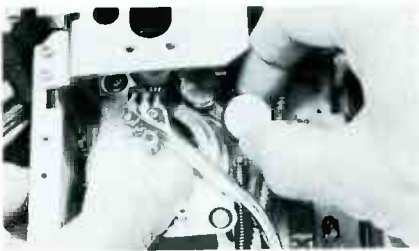

**Step 9.** Idler wheels, like rubber belts, over a long period can become contaminated with lubricant. You can't tell by looking at them. So remove all idlers and pulleys and clean them with alcohol. Make this a standard part of your servicing procedure. If you prefer to soak them in alcohol, that's okay, too. After you've reassembled them, go over the drive surfaces again with a Q-Tip and alcohol, just to be on the safe side.

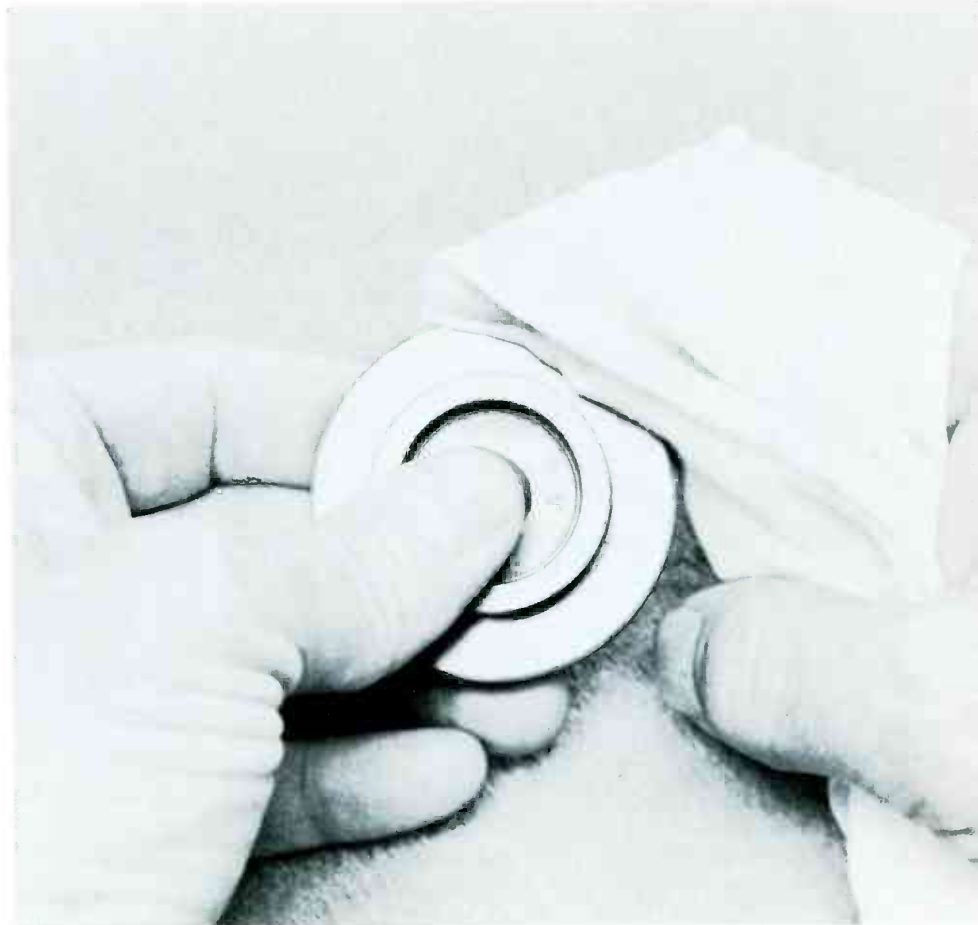

**Step 10.** Remove the flywheel and clean it thoroughly with a cloth, especially the shaft and drive surfaces. Alcohol is the solvent for this, as usual. Use a clean cloth or Q-Tip.

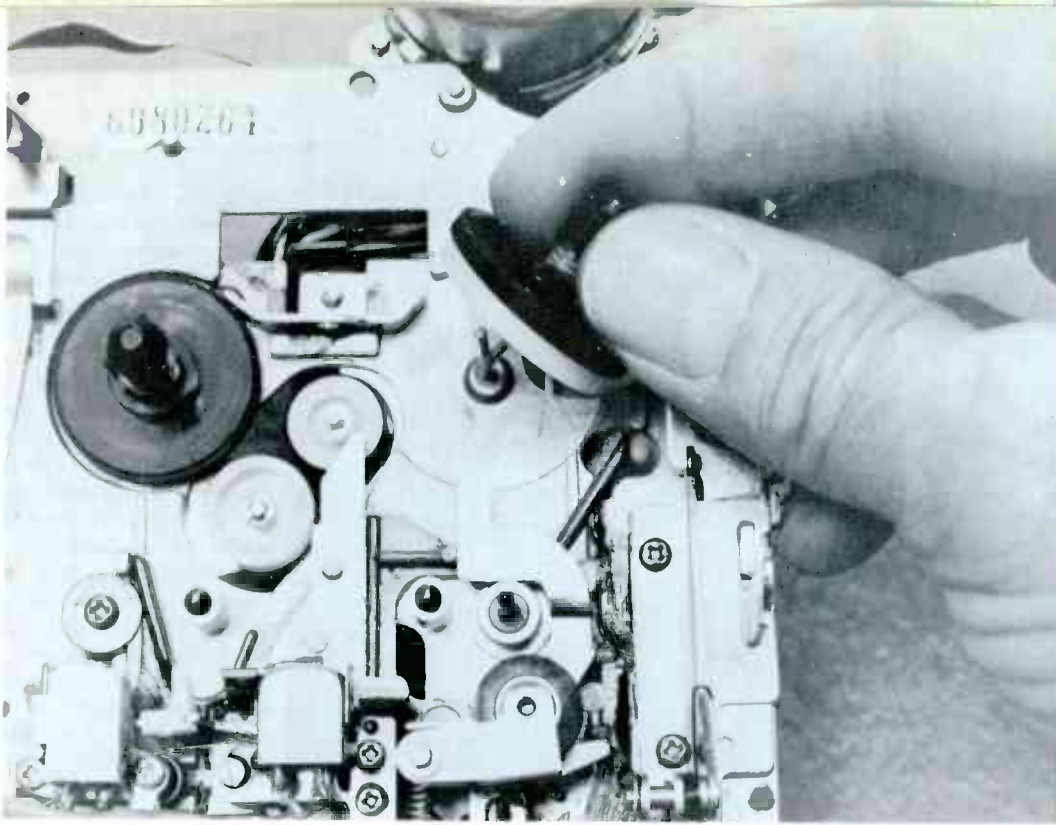

**Step 11.** When felt take-up drive clutches age, they mat down and harden, introducing another kind of slippage. Tape tangles are the usual symptom of this defect. Remove and disassemble the takeup spindle-and-clutch assembly. Soak it for 30 minutes or so in alcohol. Brush the felt lightly with moderately-stiff bristles to restore the felt to a soft, fluffy condition. Allow it to dry before you reassemble the spindle. If the felt looks at all worn, replace it. That precaution might save you a callback.

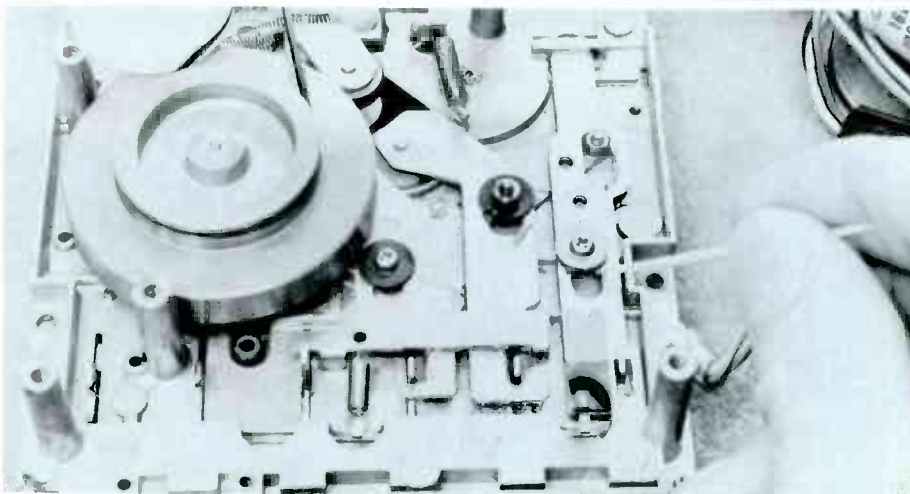
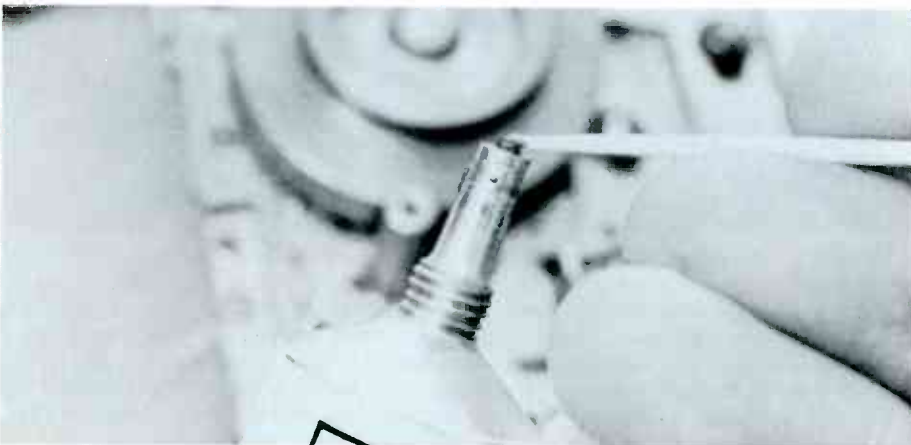

**Step 12.** After all the cleaning is done, apply a thin layer of Phonolube or similar fine grease to the slide surfaces that contact other assemblies or the baseplate. Don't overlubricate; a little goes a long way (in more ways than one). Never use oil. It migrates and soon contaminates drive surfaces.



**Step 13.** Before you reassemble idlers and pulleys, dab a tiny bit of lube on their spindles only. Don't apply it in the center holes. Slip the idler onto the shaft and turn it several times as you seat it. That distributes the fine grease along the entire shaft or spindle. Swab away any that oozes out around the center hole, using alcohol on a Q-Tip.

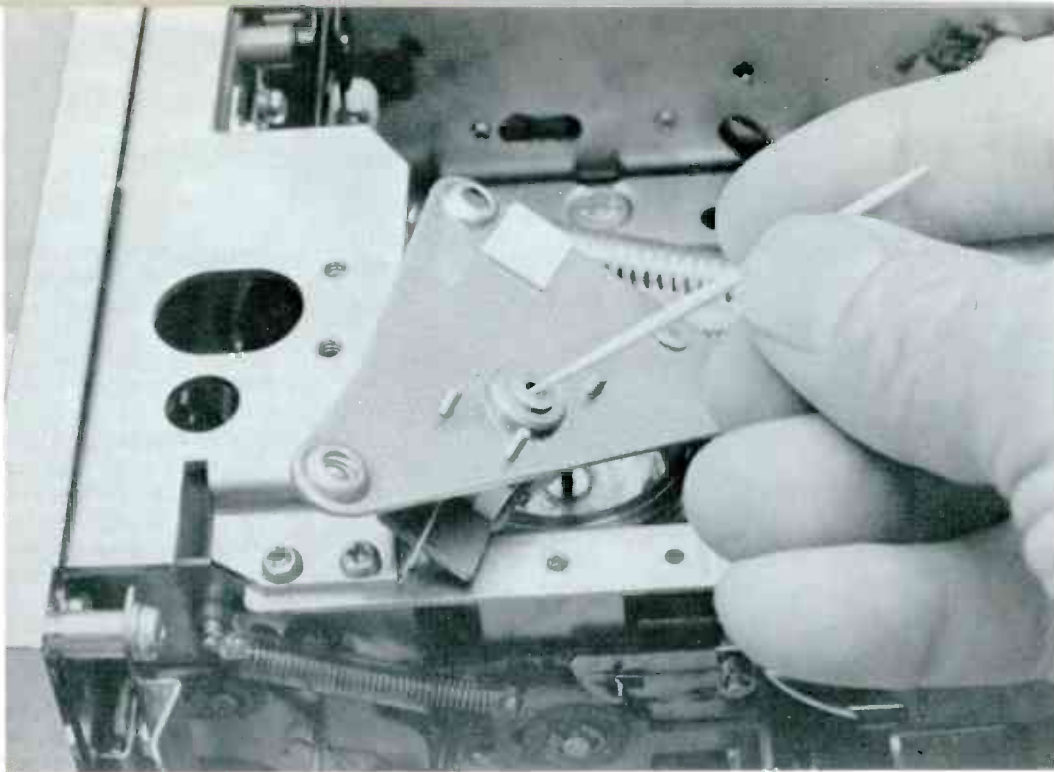

**Step 14.** The flywheel bearings in most cassette machines are self-lubricating. However, in some models, the flywheel needs yearly lubrication—especially the lower bearing. Apply a small bit of grease to the inside of the lower bearing before you reassemble the flywheel retainer bracket. Use a toothpick as applicator. If the upper bearing, at the capstan, takes lubrication (this is rare), replace the seal securely, and then clean the capstan thoroughly with alcohol. Lubricate, but don't overdue it.



**Step 15.** Oxide deposits from the tape build up on the faces of record/play and erase heads. You may hear squeaks or erratic volume when you play a tape. Also, this condition is hard on tapes. Use a Q-Tip and alcohol to remove the oxide layer. NEVER use a metal tool, even with cotton on it. You might score the head; even a minute scratch fouls up performance and wears out tapes. Too, the metal tool might magnetize the head.

**Step 17.** Before you begin testing the machine's operations, inspect it thoroughly. Hunt for loose wires that might interfere with the movement of levers, slides, or other assemblies. Look for springs and linkages that have come loose. Also check for bent slides and levers.

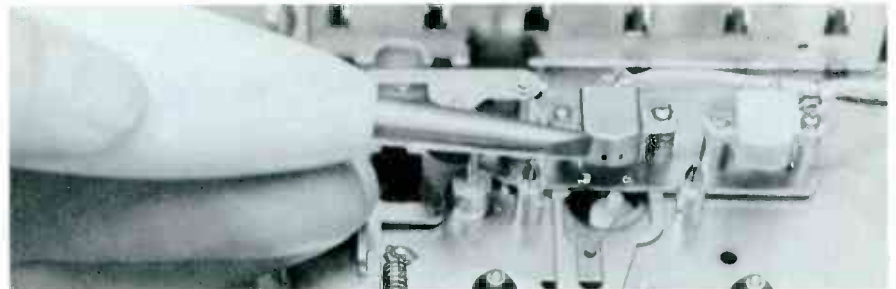

**Step 16.** Tape heads have a tendency to accumulate residual magnetism. This can be blamed on the transients caused by switching the heads from play to record, from repeated contacts with magnetized tapes, and from magnetized tools used too near the heads. Always demagnetize the heads as a final step of your servicing procedure. Turn on the degaussing tool and move it round and round near the heads. But never let it touch the head faces; it likely would scratch the smooth surfaces. Scratches scrape oxide from the tapes, ruining them in time, and causing oxide build-up on capstan and heads. Before you turn off the degausser, move it at least two feet from the heads (so the collapsing field can't re-magnetize them).

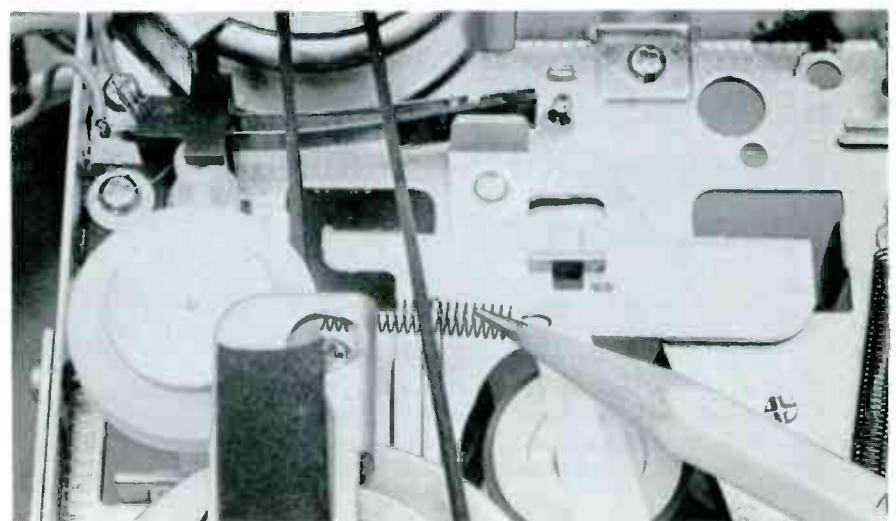



**Step 18.** Front-panel controls usually consist of pushbuttons or a function knob, a pause button, a record button, and an eject button or knob. Verify free movement for all these controls and pushbuttons. None should bind, nor should there be any excess play or looseness. See if all controls and buttons do what they're supposed to do.



### Next Month

This concludes our first Cassette Workshop session. You've seen major assemblies typical of many cassette recorders. You've learned to clean, lubricate, and inspect the mechanism. The next Workshop session goes deeper into servicing procedure: testing and adjustments. You'll see how to track down specific faults and how to adjust various assemblies to insure proper operation. The third and fourth sessions then guide you through the three most-common basic cassette mechanisms. □



MODEL 3916

The "Dip-Clip" is specially designed to allow the attachment of test probes to 14 or 16 lead DIPs. The unique patented design greatly reduces the possibility of accidental shorting while testing live circuits. Numerous test probes may be quickly connected for hands-free testing.

# dip clip

T.M.

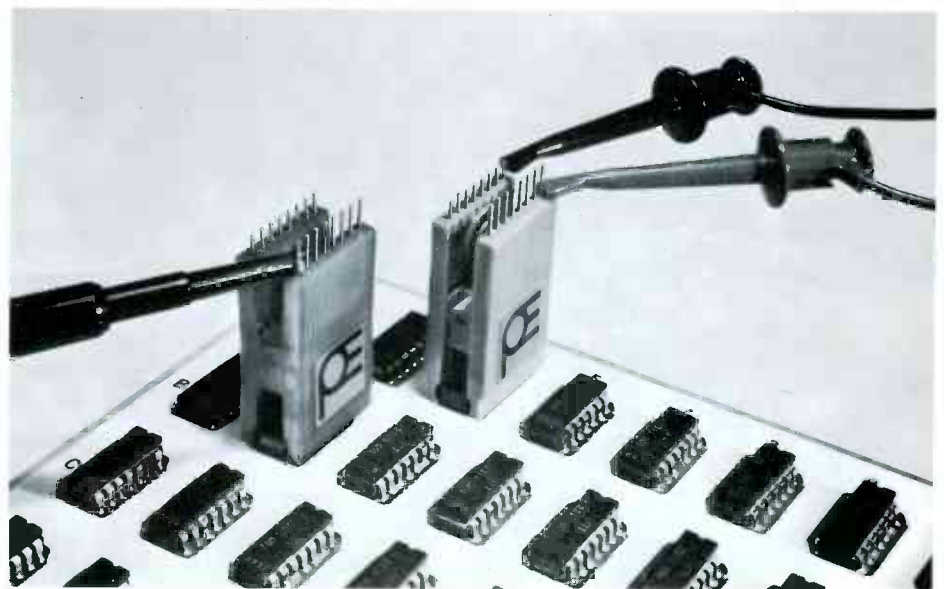

**POMONA ELECTRONICS**  
A Division of ITT

1500 E. Ninth St., Pomona, Calif. 91766 • Telephone: (714) 623-3463

For More Details Circle (12) on Reply Card

# Expanding into CB service

By Leo G. Sands

Millions of Citizen's Band (CB) transceivers have been purchased, and it's estimated 50,000 more are sold each month. In time, the number of CB radios might exceed the number of TV receivers. It's logical to expect the installation and service of these units also to be a huge industry. However, a general shortage of competent repair stations has stunted that part of the business. Many CB units are operating poorly, while others are not being used, or have been junked.

The logical source of CB service is the several thousand shops which repair commercial mobile radios. Unfortunately, there are too few of them, and many prefer to do business with industrial and public-safety organizations instead of individual customers.

Operators of TV-repair shops would seem to be the next best source of CB service. Yet, not enough TV shops will repair CB equipment, even if they are asked.

Here are some of the reasons

given for refusing to service CB units:

- TV repairs pay better;
- I don't want to buy a lot of expensive equipment;
- I don't want to install radios in cars; and
- It's too much trouble to study and get the FCC license.

Let's discuss these reasons, and see if they are valid.

## Pricing CB Repairs

The returns from a recent survey indicated a typical rate of \$16 per hour for CB repair labor. This seems compatible with charges for TV service. Therefore, it appears practical to operate from your TV price list until you accumulate sufficient records of income and expenses to make possible an accurate pricing system.

In addition to income from labor, there are many possibilities of profit from sales of parts and accessories. More information about this aspect later.

## Necessary Equipment

In addition to the test equipment required for TV servicing, you will need the following:

- a frequency meter, or electronic counter, capable of measuring frequencies up to 27.26 MHz with an accuracy of .0025% or better;
- an RF wattmeter with built-in 50-ohm dummy load, or Standing-Wave-Ratio (SWR) meter with external 50-ohm dummy load, capable of indicating up to 5-watts RMS of power;
- a 23-channel CB transceiver, modified for tapping the last IF stage for scope connection to permit observation of AM and Single-Side-band (SSB) signal envelopes; and
- a variable-voltage DC power supply for operation of 12-volt mobile units on the bench.

Both the frequency meter and power supply are useful for other jobs around the shop, so only the transceiver and RF wattmeter are for CB work alone.

## Mobile Installations

The installation part of CB busi-

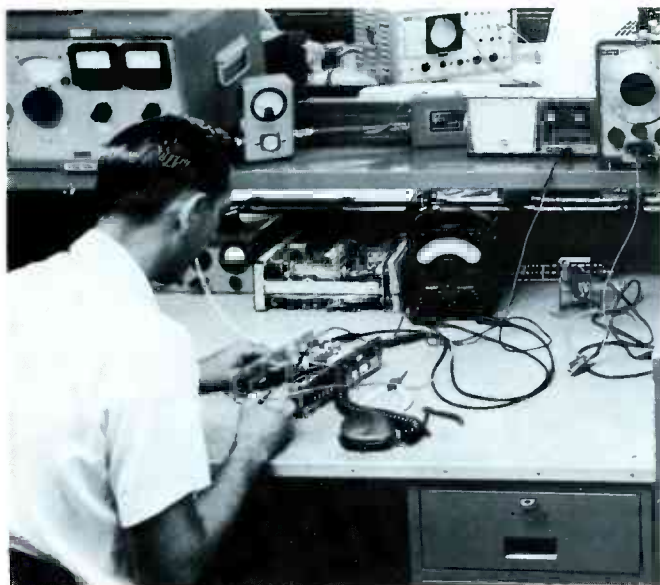

The receiver section of a CB transceiver is being checked on the bench.  
*Courtesy of Pearce-Simpson Corporation*



One example of a direct-reading frequency counter.  
*Courtesy of Syton-Donner Corporation*



It's preferable to have one instrument measure VSWR, power in watts, and percentage of modulation.

*Courtesy of Fanon-Courier Corporation*



A 23-channel AM/SSB base-station transceiver (such as this one by Pearce-Simpson) can be used with a scope to check off-the-air carrier waveforms.

ness is optional. If you have the equipment and are not opposed to that kind of work, you can make a profit. However, many CB owners prefer to do their own installations, and then take the car to a service shop if they have problems. In such cases, you can make money correcting the owner's mistakes, and by eliminating ignition noise.

Repairs often are handled the same way. The owner removes the transceiver, brings it to your shop, and comes back for it after the repair.

### The FCC License

FCC rules require any technician who repairs or adjusts the transmitting portion of a CB transceiver to have either a Second-Class Radiotelephone Operator license, or a First Class license.

Although many technicians dread the ordeal of taking the examination, the problems are more psychological than actual. If you thoroughly understand color TV, or have passed the CET examination, you should have no big difficulty in passing the FCC exam.

The worst problem is that the exam is designed to cover **all** categories of jobs for which the holder of such a license is eligible. For example, many of the questions are about high-powered transmitters employing tubes, radio station operating practices, and other things not relevant to servicing CB equip-

ment. There are few questions about transistors and other modern subjects.

Several license-exam manuals are on the market, and it's advisable to study one thoroughly before taking the exam.

One bright spot is that any number of technicians can work on CB radios under the direct supervision of one who is a license holder.

### Practical Servicing

Servicing CB transceivers is far less difficult than servicing TV's. Of course, there's a lot of circuitry on circuit boards crammed into a small space, but most are relatively-simple basic circuits.

If you know how to align and troubleshoot solid-state radio receivers, you should have little trouble mastering the servicing of CB units.

And many sources of printed material are available to reduce wasted time while you learn. Schematics usually can be obtained from the manufacturers, and the most popular schematics and service data are available in 52 volumes of the Photofact CB Radio Series. Also offered by Howard W. Sams is the book number 20722 entitled "CB Radio Servicing Guide." Or if you want a complete course, there's one from CB Radio Repair Course, Inc., 15 South Overmyer Drive, Oklahoma City, Oklahoma 73127.

The first literature you should obtain is the FCC Rules and Regulations, Volume VI, Part 95. Send \$3.50 to:

Superintendent Of Documents  
U.S. Government Printing  
Office  
Washington, DC 20402

### Replacement Parts

Component parts for current and fairly-recent models are usually available from the manufacturer or distributor. However, it may be difficult or impossible to obtain non-standard parts for CB transceivers no longer on the market. Most receiver coils and IF transformers can be substituted by J. W. Miller or other brand equivalents.

Effective in September, 1974, all new transceivers sold or first licensed must be FCC type-accepted. Most older models have not been type-accepted. Any defective parts in type-accepted transceivers must be replaced **only** with factory-furnished or factory-approved parts. This does not apply to the older non-type-accepted transceivers. However, after September 23, 1977, only type-accepted transceivers legally can be operated.

### Going After Business

After you have obtained the equipment and the technical information necessary to repair CB radios, you must let your pro-

spective customers know your services are available. The following are tested ways of reaching CB customers.

Buy an ad in the telephone directory "yellow pages" under "Radio Communication Equipment and Service." Occasionally, run a small ad in your local newspaper. Place a sign in the shop window. Then, as soon as the local CB's start coming to you for repair service, they will tell others if they like your work. After they talk about it over the air, many others in the area will know about your CB repair service. These radio commercials reach the audience you need, and they are free.

Many communities have a REACT (Radio Emergency Associated Citizens Teams), or an ALERT (Affiliated League of Emergency Radio Teams) organization whose members provide public-service communications on a voluntary basis. Almost any local CB operator can tell you if there is such a team, and where to contact its officers.

You can send cards or bulletins by mail to CB owners. Names and addresses of newly-licensed operators in your area can be purchased from J. B. Carney, 15 South Overmyer Drive, Oklahoma City, Oklahoma 73127. When requesting a quotation of the prices of mailing lists, specify ZIP codes of the territory you want to cover.

Another way to get customers is to write to the national service managers of CB equipment manufacturers and distributors and advise them you are available for CB servicing. Manufacturers need local service to keep the customers satisfied with the equipment. Although some manufacturers and distributors operate their own national or regional service centers, their customers prefer not to have the equipment gone for weeks.

If repairs will require more than a few days because it's necessary to order parts, it's an excellent idea to keep extra transceivers on hand for loan to your customers.

### Set Up Your Own CB Station

A good sales-promotion idea is to set up a CB base station at your shop so customers can call you over

TABLE I

## CB EQUIPMENT MANUFACTURERS

Beltek c/o Pal Electronics Co. P.O. Box 778 Westminster, CA 92683	Midland Electronics Co. 100 West 12th St. No. Kansas City, MO 64123
Browning Labs, Inc. P.O. Box 310 Laconia, NH 03246	Pace Division Pathcom, Inc. 24049 S. Frampton Ave. Harbor City, CA 90710
Cobra Division Dynascan Corp. 1801 W. Belle Plaine Chicago, IL 60613	Pearce-Simpson Div. Gladding Corp. PO Box 800 Biscayne Annex Miami, FL 33152
Fanon/Courier Corp. 990 S. Fair Oaks Ave. Pasadena, CA 91105	J.C. Penney Company, Inc. 1301 Avenue of Americas New York, NY 10019
American Trading Corp. 29245 Stephenson Highway Madison Hts., MI 48071	Radio Shack 2617 West Seventh St. Ft. Worth, TX 76101
Metronix Corp. 8237 Remmet Ave. Canoga Park, CA 91304	Royce Electronics Corp. 1142 Clay St. North Kansas City, MO 64116
Hy-Gain Corporation 8601 Northeast Highway 6 Lincoln, NE 68501	Linear Systems, Inc. 220 Airport Blvd. Watsonville, CA 95076
E. F. Johnson Company 229 Tenth Ave. SW Waseca, MN 56091	Siltronix P.O. Box 80787 San Diego, CA 92138
Kris, Inc. One Echo Plaza Cedarburg, WI 53012	Sonar Radio Corp. 73 Wortman Ave. Brooklyn, NY 11207
Lafayette Radio Electronics Corp. P.O. Box 450 Syosset, L. I., N.Y. 11791	Teaberry Electronics Corp. No. Shadeland Indianapolis, IN 46226
Mark Products 5439 W. Fargo Ave. Skokie, IL 60076	Tram Corporation P.O. Box 187 Winnisquam, NH 03289



A typical variable-output 12-volt DC power supply for operation of mobile units on the test bench.

Courtesy of Pace  
Division of Pathcom

the air when one of their units needs repairs, or when they might have a question. You will need a CB transceiver, an antenna system and a CB station license.

To obtain a station license, write to the Federal Communications Commission, Washington, DC 20554 and ask for a Form 505. After filling out the form, send it and a check for \$20 to the FCC at Gettysburg, Pennsylvania. One license covers any number of your transceivers, and is good for five years, unless revoked earlier for violation of FCC rules.

It is not unlawful to communicate via CB radio with customers or prospective customers just so long as you don't broadcast blatant commercials. Motels, for example, use CB radios for accepting reservations from motorists. After you install a CB base station, let your customers know which channel you will be monitoring.

### Your Responsibility

Although the licensee of a CB transceiver is responsible to the FCC regarding compliance with FCC technical standards, your customer properly looks to you to insure that compliance.

You should keep comprehensive records of all work you perform, noting specific repairs and adjustments, when made and by whom. Of course, you should record the make, model and serial number of each transceiver serviced, as well as the customer's name, address, and station license call sign. When you measure transmitter frequencies, the actual frequency should be recorded; just "OK" will not do. If your customer is cited for a technical rule violation, an FCC engineer might want to examine your records.

### Additional Income

Because the equipment is small in size, most customers will bring defective transceivers to the shop for repairs. However, there are times when house calls are necessary. For example, a CB owner who has no technical knowledge installed his own antenna system, but doesn't know how to tune it correctly. This requires a house call and the use of a SWR meter.

Also, when a CB base station interferes with television reception nearby, a house call usually is required to determine if the CB unit has a defect. CB radios are well shielded and use coax lead wire, therefore a low-pass filter usually is all that is needed to make certain no illegal harmonics are broadcast. Of course, just as with amateur-radio operation, most cases of interference with TV reception are the fault of the TV's, not the radio transmitters.

In addition to profit from service labor and the sales of repair parts, there is money also to be made by selling replacement and higher-performance antennas (both mobile and base), as well as lower-loss coaxial cable, TVI filters, microphones and other accessories.

Income further can be increased by installing both base stations and mobile radios, either for retail customers or for local dealers. Suppressing ignition noise in cars is another profitable sideline.

Sell your customers on the need for periodic check-ups. Although not required by FCC rules, CB transmitting frequencies should be measured at least once a year, or oftener. Also, because mobile units are subjected to mechanical shock, vibration and wide variations of temperature, they should be realigned every few months.



Base station work includes the assembly and erection of the antenna.

### Don't Encourage Illegal Activity

Unfortunately, some CB operators use their equipment in ways that are illegal. Originally, the CB band was set aside for individual businesses or families to communicate between their own stations, and **only** those. Since that time the rules have been relaxed slightly, permitting brief exchanges of essential messages between stations having different call signs.

However, the CB band is **not** to be used for communicating more than 150 miles, and is **not** for "chit-chat, idle conversation, discussion of equipment, or hobby-type communications," as stated in the application Form 505.

There are other technical limitations on antenna height, power output and amount of modulation. Unfortunately, some CB operators have taken advantage of the difficulty in enforcing the rules and have added powerful linear amplifiers, taller towers and other illegal items of equipment. You, a technically-trained citizen, should **not** help install such equipment, encourage its use, or give advice as to how it can be used.

### Summary

Only lack of competent repair services and the extra clutter of the channels by illegal operation hold back the rapid growth of Citizen's Band radio. The repair rates are good, and the requirements of education and equipment are moderate. Therefore, you might find CB repairs to be a very profitable sideline for your present business. □

Installation of a CB radio transceiver is similar to installing an auto radio.





# Tracking down HV regulator problems

By Robert L. Goodman

*These actual case histories show various types of high-voltage regulators, how to troubleshoot them, and some picture symptoms produced by typical parts failures, plus one example of narrow width.*

## Snap, Crackle and Pop

It wasn't a breakfast food, but this Zenith color set with a 20Y1C50 chassis would snap, crackle and pop when first turned on. The picture had plenty of brightness, but was slightly blurred (Figure 1). High voltage measured 30 KV at normal brightness. Size of the picture changed somewhat as the brightness was varied. These symptoms pointed toward a loss of HV regulation.

## Circuit analysis

The regulator circuit (Figure 2) is of the pulse-type using a 6HS5 tube. Basically, the high voltage is regulated by maintaining a constant AC load in the flyback circuit. Although there is some voltage drop across the tertiary winding of the flyback, and the forward resistance of the rectifier tube that is

not compensated for, quite good HV regulation can be attained by keeping a constant amplitude of pulses at the damper. Amplitude of the pulses to the HV rectifier tracks quite well with the amplitude of the damper pulses.

Control voltage for regulation logically should be obtained by way of a voltage divider from the DC high voltage. But the resistors are expensive, require insulation against HV, and often are subject to extra failures. Years ago it was discovered that, when the DC high voltage was changed because of a different picture-tube current, the B-boost varies closely in step. Therefore, most shunt-regulator circuits (both AC and DC types) obtain their control voltages from the B-boost supply. (Certain parts defects can upset the tracking of DC HV and B-boost. For example, an open yoke in a tube circuit produces too much B-boost and insufficient HV).

At maximum brightness, no reduction of HV is desired; so the HV-Adjust control and the associated resistors should supply the control grid of V14 with a voltage barely sufficient to cut off the plate current. If the brightness is reduced, B-boost rises, decreasing the

cutoff bias of V14, and the tube draws some current during each horizontal pulse.

This is a closed-loop system, so it is self-compensating to a large degree (following initial adjustment of the HV-Adjust control). Ideally, the AC load on the flyback should be constant for any reasonable value of picture-tube current.

There is one important consideration: regulator current must flow **only** during the same small portion of each pulse as that of the HV rectifier. Any current flowing during the entire cycle, would adversely affect the width and linearity. Narrowing the pulses of regulator current is the job of C93 and the pulses from the horizontal oscillator. The small value sharpens the pulses, and the instantaneous grid bias is determined by the DC bias **and** the amplitude of the horizontal pulses through C93. Addition of C94 reduces the amplitude of pulses without changing the waveshape (C93 and C94 form a capacitive voltage divider).

These facts are necessary for us to understand why it is not practical to adjust the regulator for a certain DC grid bias, or measure the DC voltage drop across the



Fig. 1 Picture on the Zenith was nearly normal, except the focus was not sharp, and the size changed with brightness.

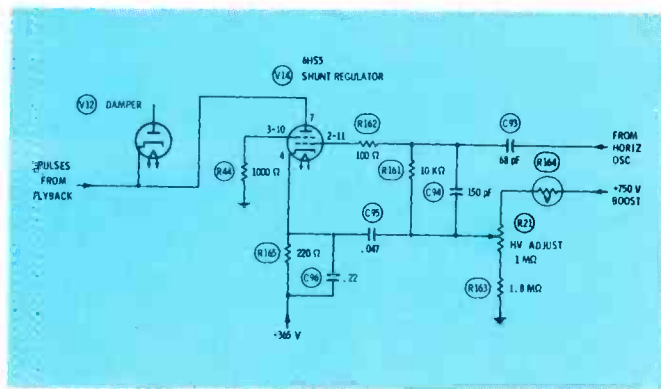

Fig. 2 HV regulator in the Zenith 20Y1C50 color chassis (Photofact 981-2) is of the low-voltage pulse-shunt type. Flyback pulse amplitude is regulated, resulting in regulation of the DC high voltage and the sweep width.

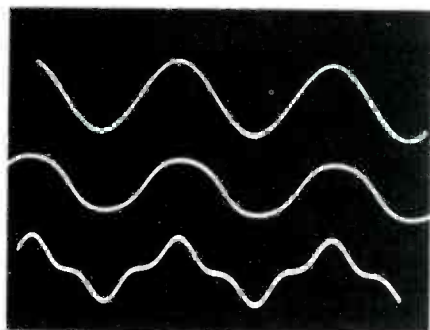

Fig. 3 Varistors (Voltage Dependent Resistors, or VDR's) are non-polarized voltage regulators of moderate action. Top trace is the waveshape of the sine waves used to test a VDR. For the center trace, the sine waves were supplied through a resistor, and the rounded tops and bottoms prove that the VDR current increased at the voltage peaks. Bottom trace is the current waveform, showing increased current at the tips of the sine waves. Notice the current is the same for positive tips as for negative ones. Varistor action is gradual, causing no sharp corners, such as those produced by diodes.

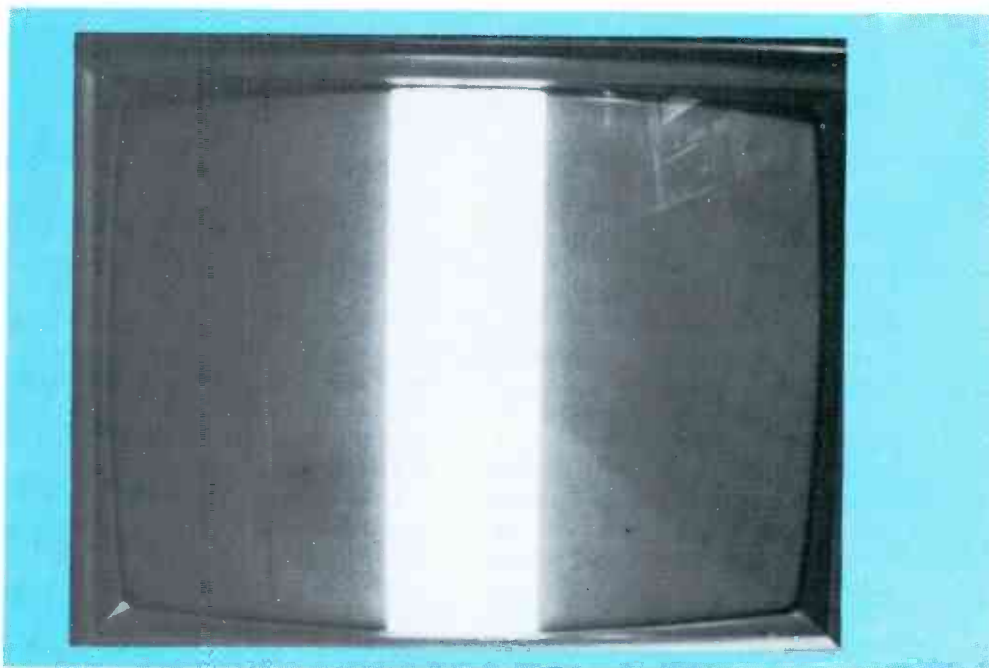

Fig. 4 This narrow raster appeared on the screen of a General Electric with an MA color chassis, when the series yoke capacitor was open.

cathode resistor (as is done with DC-shunt systems). Instead, performance of the regulator usually is judged by its effect on the high voltage.

One more component needs an explanation, and that is R164, which is a varistor, or Voltage-Dependent Resistor (VDR). A VDR reduces resistance when the voltage across it is increased. In other words, it acts as a kind of voltage regulator (see Figure 3). So, R164 passes on to the grid of the regu-

lator **more** of any change of B-boost voltage than would be possible if R164 were a linear type.

#### Troubleshooting

The initial diagnosis was loss of HV regulation, and this was confirmed when grounding the grid of the regulator tube failed to change the high voltage. Some of the defects that can prevent regulation are:

- loss of pulses at the grid, perhaps from an open C93, or shorted C94 (use a scope to measure the pulses);

- open R165, cathode resistor; or
- a bad part that reduces the DC positive voltage supplied to the grid. This assumes that the regulator tube is not defective, the socket does not have an open, and the heater is lit.

**Caution.** Pin 7 of V14 has the same DC and pulse amplitude as the cathode of the damper. Therefore, do **NOT** attempt to measure the voltage there; the pulse amplitude could ruin your meter or scope.

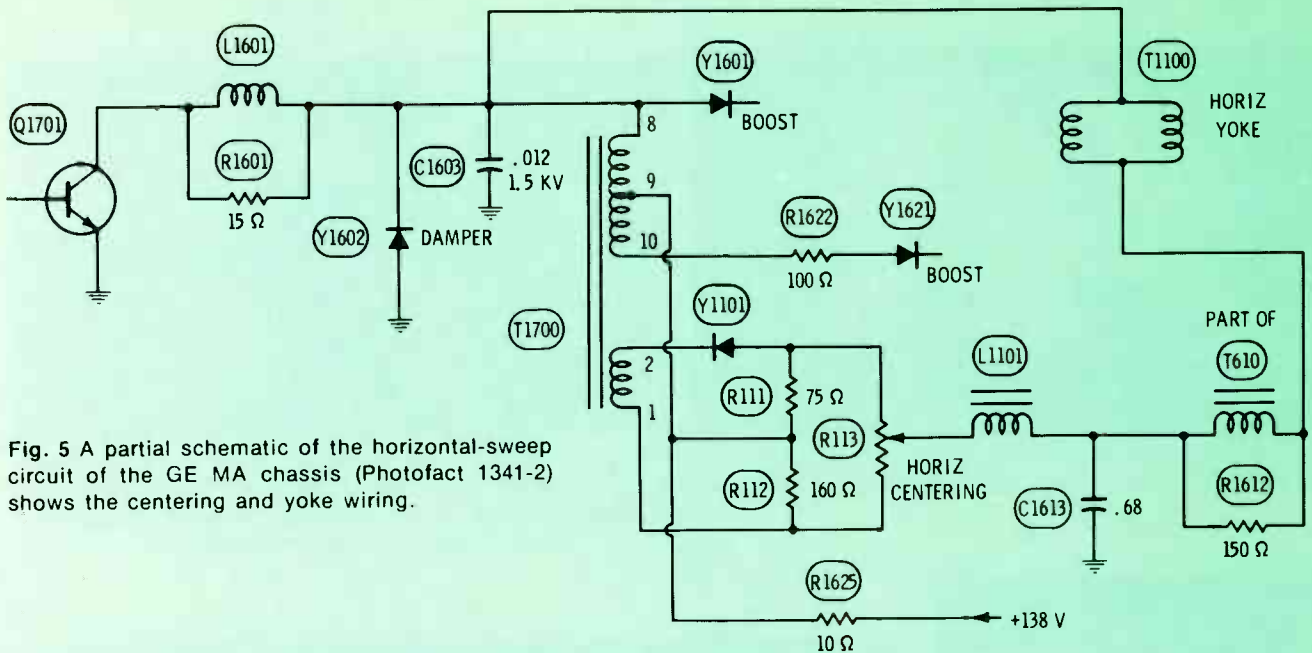

Fig. 5 A partial schematic of the horizontal-sweep circuit of the GE MA chassis (Photofact 1341-2) shows the centering and yoke wiring.

In this case, everything checked normal, except the grid voltage was not sufficiently positive. Ohmmeter tests revealed that the varistor, R164, was open. A new part and a touch-up of the HV-Adjust control finished the job.

#### Other side of the problem

It's just as likely for the shunt regulator to draw excessive current and eliminate or reduce the high voltage. First, operate the receiver with V14 removed from the socket. A change to excessive HV proves regulator current was responsible. Then you should check for conditions opposite the ones previously given. For example, a shorted C95 reduces the grid bias to nearly zero, and the tube over-conducts. Strangely enough, an open C95 also causes excessive conduction because it produces the same effect as an open C94, increasing the amplitude of pulses at the grid. Other possible defects are leakage in C93 or an increased value of R163.

#### Narrow Picture

A narrow raster appeared on the screen of the MA/MB chassis General Electric color receiver (Figure 4). That was the only symptom; sound and video both were good.

#### Circuit analysis

The horizontal-output stage is reasonably typical of non-SCR circuits (Figure 5 taken from Photofact 1341-2), because there is a single output transistor paralleled by a damper diode and a flyback transformer. C1613 is the yoke-tuning capacitor, and the value is moderately critical.

One difference from other similar stages is the horizontal-centering circuit. Diode Y1101 scan-rectifies the pulses from one winding of the flyback (T1700), producing a negative voltage which moves the picture sideways when the horizontal-centering control is adjusted. L1101 blocks the pulses from the transformer, but passes the DC necessary to change the centering. R1612 and the one winding of T610 shown in Figure 5 are a part of the pincushion circuit.

Notice that the horizontal-yoke coils are in parallel, the usual arrangement for transistor circuits. Therefore, shorted turns in one coil reduces the width or kills the HV instead of showing a trapezoidal picture.

#### Troubleshooting

A replacement yoke was handy, so it was installed temporarily. The width was not increased.

Drive signal to the base of the horizontal output transistor was normal, as was the +138 volt supply. Waveshape and amplitude of pulses at the collector of Q1701 were wrong, but did not appear to indicate shorted turns in the flyback transformer (low-amplitude, narrowed pulses should result from shorted turns there).

As a test, a .47 paper capacitor was connected from ground to R1612, and immediately the picture widened almost to normal width. **C1613 was open.** Some width had been obtained because of the AC return through L1101 and the centering circuit.

#### Other defects

In other repair jobs, C1613 was shorted, causing loss of raster and tripping of the circuit breaker. An open horizontal-width coil (not shown; it is in the MB chassis only) also can cause loss of width.

If Y1101 centering diode is open or shorted, the picture is shifted to one side, and the centering control action is wrong.

#### No Regulation

The picture on the screen of a Zenith with the 15Y6C15 chassis appeared to be normal. However, the picture size changed excessively



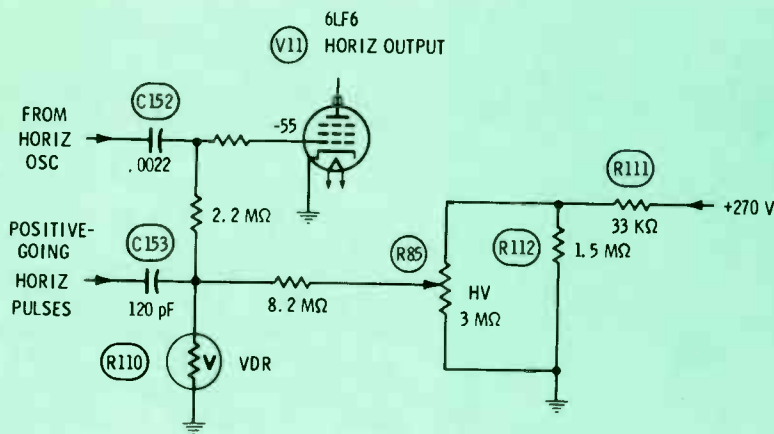

Fig. 6 The Zenith 15Y6C15 sweep circuit increases the negative grid voltage of the horizontal-output tube to reduce the sweep width and high voltage. A VDR is used instead of a diode to "rectify" the pulses and produce a negative control voltage. **Don't use a diode to replace the varistor!** There would be too much negative voltage, causing a narrow picture, and the diode probably would short out quickly.

when the brightness control was adjusted between a dim and a bright picture. The strange part of the symptom was that the width was better at high brightness; just the reverse of width troubles caused by weak horizontal sweep power. This is a sign of HV regulation that is over-controlling, and the diagnosis was confirmed by measurement of the HV at the picture tube; the HV was higher when the picture was brighter.

#### Circuit Analysis

In this model, HV regulation is accomplished by changes of the output-tube grid bias (Figure 6). Maximum sweep power and high voltage are obtained when the grid bias of V11 is the same as that produced alone by grid rectification of the signal from the horizontal oscillator. Any voltage more negative than that at the grid, limits the maximum plate current, resulting in less sweep and HV power.

Stripped to the essentials, the circuit of Figure 6 "rectifies" pulses coming from the flyback and generates a negative voltage that varies with the amplitude of those pulses. It's a closed-loop action; the higher pulse amplitude causes more negative voltage; and the more negative voltage the lower the amplitude of

the pulses. Thus the amplitude of the flyback pulses is regulated. And because the HV varies nearly in step with the flyback pulses, the HV also is regulated.

#### Why the varistor?

Substitute a diode with its cathode grounded for the varistor (Voltage Dependent Resistor), and the combination of C153 and the diode becomes a shunt-type of peak-reading rectifier circuit, producing negative DC voltage. However, the waveforms of Figure 3 prove a varistor responds the same to either positive or negative voltages, unlike a diode, which conducts only during one polarity.

The natural question is: how can negative DC voltage be generated by a rectifier circuit when the diode is replaced by a varistor? The answer involves the **waveshape** of the signal. If **sine waves** of 15,734 Hz were fed to C153, no DC voltage could be produced by R110 and C153. But, **positive-going** pulses permit a specialized kind of "rectification", resulting in a negative voltage. The remainder of the explanation is found in Figure 7. (Negative-going pulses—without any change of parts or circuit—would produce **positive** voltage. Therefore, make certain of the polarity of

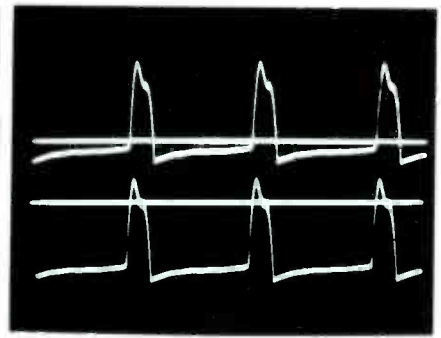

Fig. 7 Here's a simplified explanation of how a varistor (that draws the same current from either positive or negative voltages) can generate a negative DC voltage in a shunt-type rectifier circuit originally designed for a diode. The top waveform is a dual-trace one using a scope's inherent ability to display a correct zero-voltage line. Any parts of the waveform above the line are positive, and the parts below are negative in voltage. Wattage of the waveforms above the zero line equals that below the line. However, a varistor operates from voltage. Therefore, if you add a varistor from capacitor to ground (see Figure 6), the varistor draws much more current on the wider, less-tall negative portions. The effect is to **ground** the tips of the pulses, which moves the zero-voltage line nearer the tips, as shown in the bottom waveform. A DC meter applied to this waveform reads a negative voltage. Rectification using a diode operates even on symmetrical waveshapes such as sine waves and square waves. **A varistor "rectifies" only pulses.** Negative-going pulses produce positive DC in this same circuit.

pulses.)

#### Why the positive voltage?

C153 and R110 alone would supply negative voltage to the grid circuit of V11. However, the voltage would change exactly in step with the amplitude of the pulses. This is not enough change of voltage for effective control of the HV. The design solution is to supply **too much** negative voltage, buck out part of it with a steady DC voltage, and apply the remainder to the output grid, reducing the sweep power.

Let's study two hypothetical examples. Suppose no positive voltage came through the 8.2 megohm resistor, and the amplitude of pulses

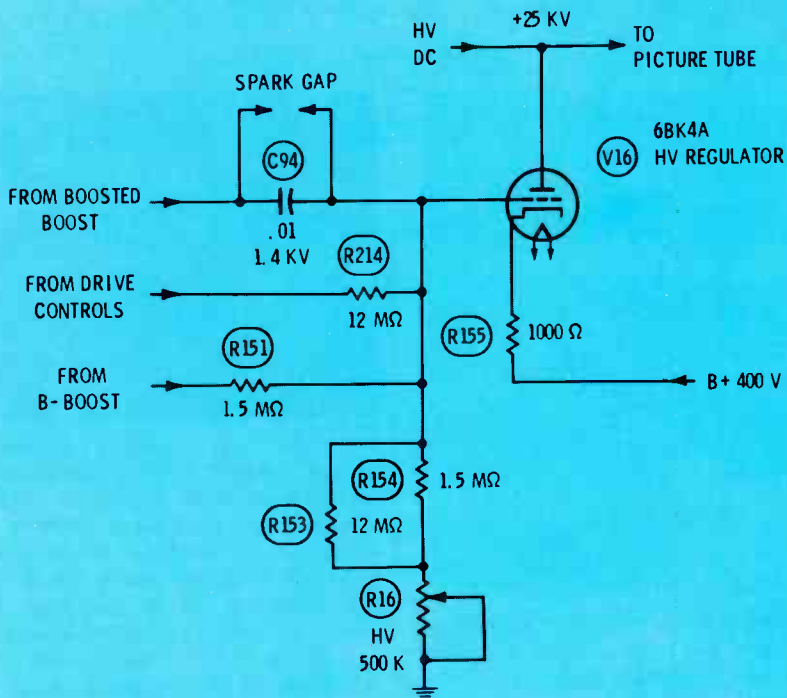

**Fig. 8** The RCA CTC17 chassis has a 6BK4A tube which regulates the high voltage by maintaining the same DC current through the HV rectifier. When the picture tube requires less current, the regulator tube draws more, etc. Bias of the 6BK4A is extremely critical for best operation.

produced -55 volts at R110. This is the same as the normal grid bias, and would make no change of sweep. A 10% increase of pulse amplitude also would raise the DC voltage 10%, increasing the grid bias of the output tube to -60.5 volts. Such a small change of voltage could not provide good HV regulation; more change is needed.

In the second example, the different flyback supplies more amplitude of pulses "rectified" by R110 to produce -200 volts. A fixed voltage of +145 through the 8.2 megohm resistor cancels all but -55 volts, leaving the grid bias unchanged. If the pulse amplitude is increased 10%, the negative voltage also increases 10% (up to -220 volts) and the 20 volt increase is passed on to the grid, resulting in a bias of -75 volts. This magnitude of change can give effective regulation.

In practice, the positive and negative voltages are balanced to equal the normal grid bias of the output tube when the picture has maximum brightness. Then, any decrease of brightness brings increased pulse amplitude, more negative voltage to increase the bias, and results in a reduction of sweep power and high voltage.

### Three sources of bias

Remember that the bias of the horizontal-output tube comes from three different voltages: a negative voltage produced by grid rectification of the oscillator signal that is applied to the grid, a variable negative voltage from the varistor "rectifier", and a fixed positive voltage (at least it is fixed following adjustment of the HV control) coming from the B+ supply.

### Troubleshooting

Voltage readings at the grid of the horizontal-output tube at both high and low brightness showed a wide variation in the wrong direction. With a dim picture, the bias was about -80 volts, and was only about -60 after the brightness was increased.

These voltages indicated excessive negative voltage at the grid, probably because of insufficient positive bucking voltage, or (less likely) too much rectified voltage at the varistor.

Additional DC voltage checks showed too much negative voltage at the varistor side of the 8.2 megohm resistor, and too little positive voltage at the other terminal. R111 had +270 volts at the B+

end and almost nothing at the other. **R111 was open**, and installation of a new one restored the HV regulation.

### Other defects

An open in either the 8.2 megohm resistor or the top end of the HV control would have given the same symptoms, and almost the same voltage readings at the output grid.

Defects eliminating the negative voltage (such as an open C153, or an open varistor) would have stopped all HV regulation. Other symptoms would have been more subtle. The negative grid bias might have been reduced by a couple of volts, but the plate current would be increased significantly.

### Picture Narrowed On Left

Crosshatch patterns showed the linearity was pinched at the left edge of the picture on the RCA which used a CTC17 chassis. In addition, focus was not very sharp and the picture would bloom out at high brightness settings. To make matters worse, at times the operation would return to normal.

### Circuit analysis

Circuit theory tells us that compression of the horizontal sweep on the left probably is caused by excessive HV current that has reduced the amplitude of flyback pulses; and weakened the damper current, which supplies the sweep for the left half of the raster.

Except for leakage from high voltage to chassis, there are only two paths for the DC HV current. One is to the picture tube, and the other is through the HV DC shunt-regulator tube.

Operation of the brightness control obviously changed the picture-tube current, and the compression still remained even when the raster was dark. Therefore, only regulator current was a suspect.

Figure 8 shows the CTC17 regulator circuit. The theory of operation is quite simple. At maximum brightness the 6BK4A should be biased to cutoff so it draws no current from the high voltage. When the picture tube draws no current (unlighted raster) the regu-

*(Continued on page 47)*

# NEED A 1/4" x 1-1/4" TIME-DELAY FUSE OR QUICK-ACTING FUSE?

# BUSS HAS IT!

Time-current characteristics of FUSETRON® dual-element time-delay fuses

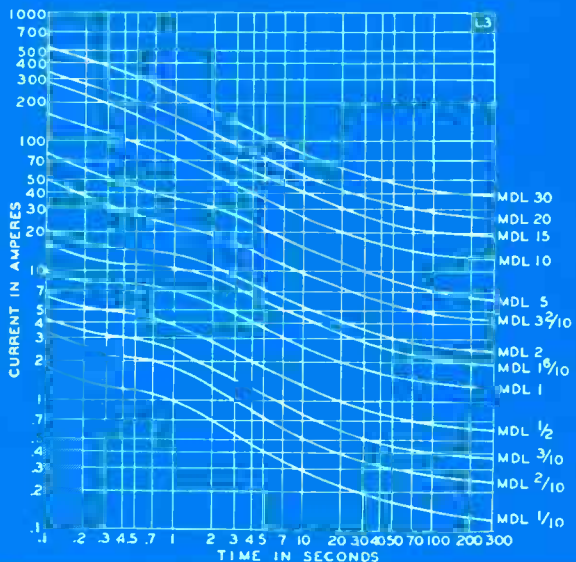

Time-current characteristics of BUSS® fast-acting fuses

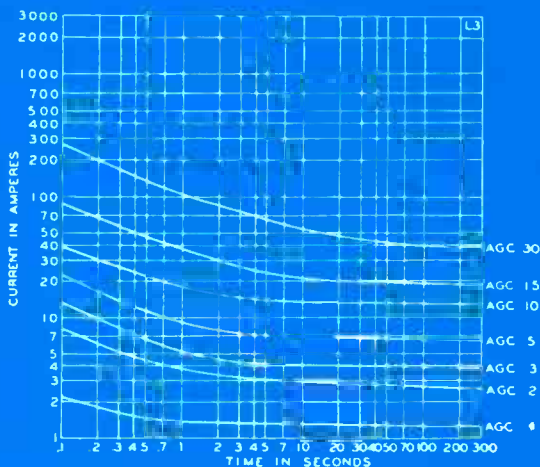

### FUSETRON® dual-element fuses

Time-delay characteristics avoid nuisance openings from starting currents or surges—yet, give full protection from short-circuits or dangerous overloads.

Voltage	Symbol	Amperes
250 or less	<b>MDL</b>	1/100, 1/32, 1/16, 1/10, 1/8, 15/100, 175/1000, 3/16, 2/10, 1/4, 3/10, 3/8, 4/10, 1/2, 6/10, 7/10, 3/4, 8/10 or 1
250 or less	<b>MDX</b>	1-1/4, 1-1/2, 1-6/10, 1-8/10 or 2
125 or less	<b>MDL</b>	1-2/10, 1-1/4, 1-1/2, 1-6/10, 2, 2-1/2, or 2-8/10
125 or less	<b>MDX</b>	3, 3-2/10, 4, 5, 6-1/4 or 7
32 or less	<b>MDL</b>	3, 3-2/10, 4, 5, 6-1/4, 8, 10, 15, 20, 25 or 30



### BUSS® fast-acting fuses

Fast-acting characteristics provide the instantaneous high speed opening necessary to protect sensitive instruments or delicate apparatus.

Voltage	Symbol	Amperes
250 or less	<b>AGC</b>	1/500, 1/200, 1/100, 1/32, 1/16, 1/10, 1/8, 15/100, 175/1000, 3/16, 2/10, 1/4, 3/10, 3/8, 45/100, 1/2, 6/10, 3/4, 1, 1-1/4, 1-1/2, 1-6/10, 2
250 or less	<b>MGB</b>	1/16 or 1/8
MBW & MBB fuses now called AGC.		
250 or less	<b>AGC</b>	2-1/2, 3
250 or less	<b>MTH</b>	4, 5 or 6
For 250 volt fuses above 6 amperes—See ABC fuses.		
125 or less	<b>GLH</b>	7, 8 or 10
32 or less	<b>AGC</b>	4, 5, 6, 7, 7-1/2, 8, 10, 15, 20, 25 or 30

For a complete selection of BUSS fuses and fuseholders ask for bulletin SFB.

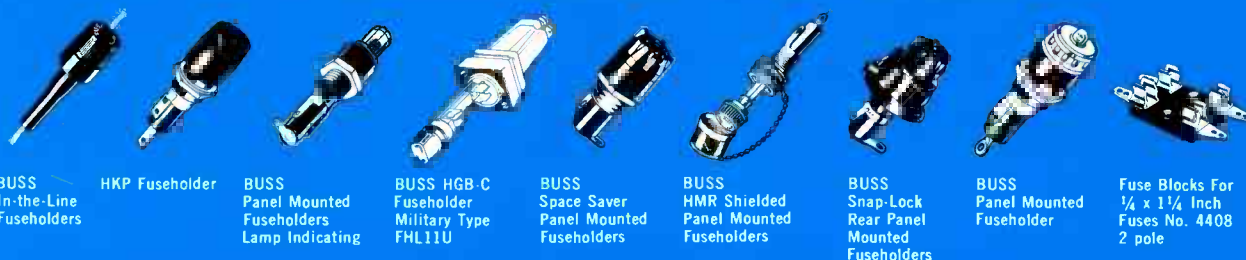

BUSS In-the-Line Fuseholders

HKP Fuseholder

BUSS Panel Mounted Fuseholders Lamp Indicating

BUSS HGB-C Fuseholder Military Type FHL11U

BUSS Space Saver Panel Mounted Fuseholders

BUSS HMR Shielded Panel Mounted Fuseholders

BUSS Snap-Lock Rear Panel Mounted Fuseholders

BUSS Panel Mounted Fuseholder

Fuse Blocks For 1/4 x 1 1/4 Inch Fuses No. 4408 2 pole



BUSSMANN MANUFACTURING  
a McGraw-Edison Company Division  
St. Louis, Missouri 63107



# Why pay more for the Quantum?

Because the Channel Master Quantum is the most highly engineered reception system available today! It uses the finest state of the art technology to provide superior color and black and white reception under any conditions, in the face of any problems.

Massively engineered to stand up under hurricane force winds and the equivalent of 12" snow loading, the Channel Master Quantum costs more because it delivers more. It's unmatched for power, directivity and flexibility!

The bold new diamond back UHF director train provides significantly increased gain ---along the entire band--- than previous Quantum models did at specific channel settings.

UHF tabs used on VHF directors eliminates any possibility of signal interaction between the two bands.

The result is a sparkling new level of crisp, sharp color and black and white performance through random channel assignments within any given area.

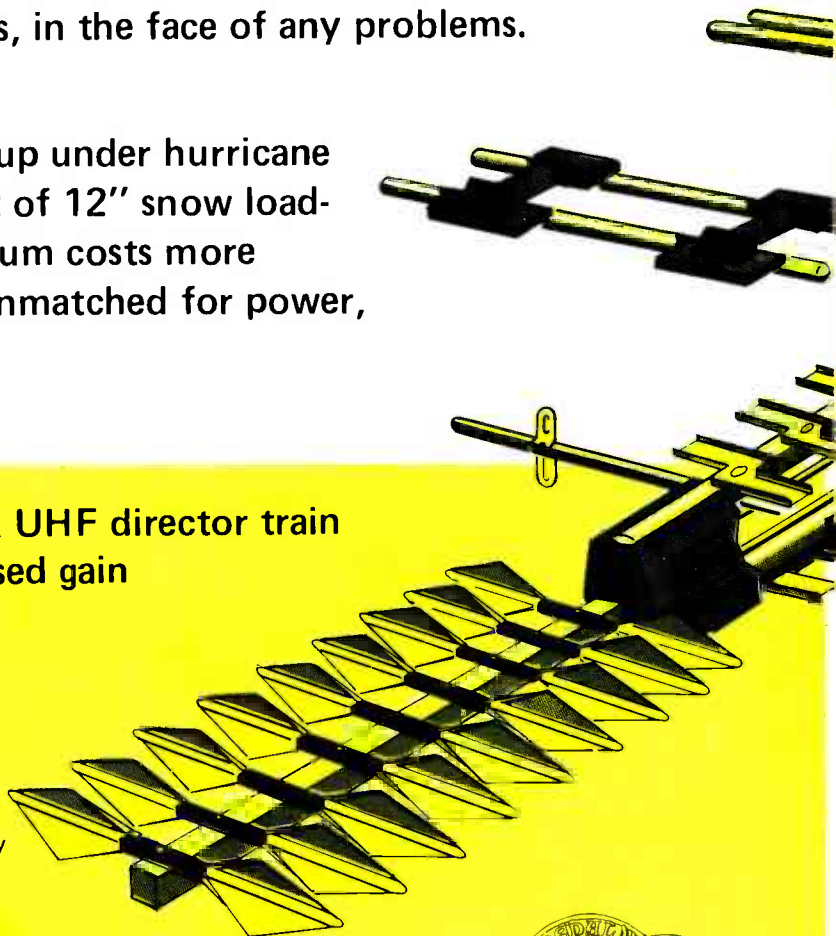

The new *Channel Master* Quantum  
costs more... and it's worth it!

FROM THE WORLD'S LARGEST MANUFACTURER OF TV/FM RECEPTION EQUIPMENT

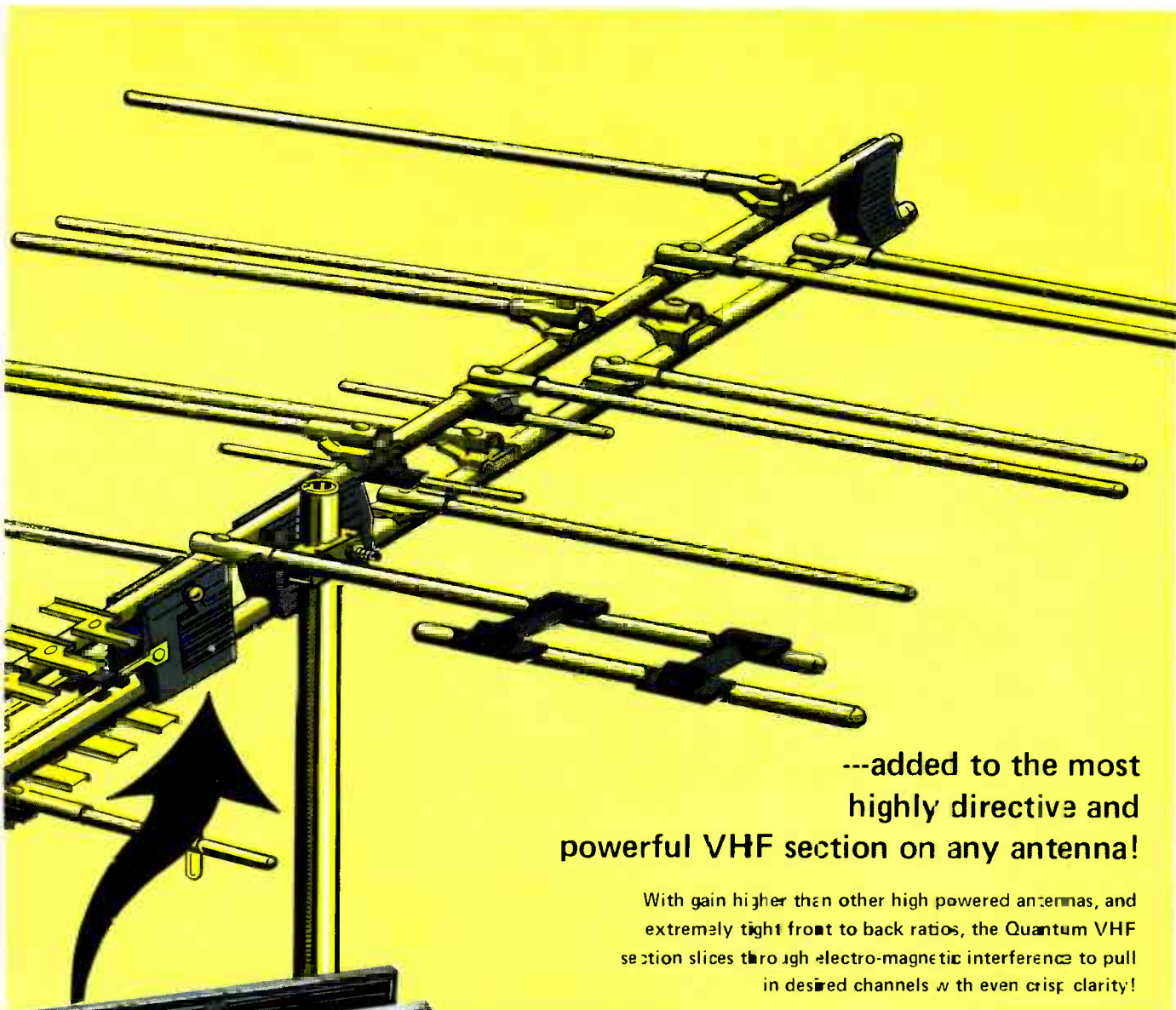

---added to the most highly directive and powerful VHF section on any antenna!

With gain higher than other high powered antennas, and extremely tight front to back ratios, the Quantum VHF section slices through electro-magnetic interference to pull in desired channels with even crisp clarity!



And for added flexibility... Custom engineered accessories slip into the Quantum's weather protected terminal housing to handle any problem you're likely to face---

- For melting snow in weak signal areas, modular solid state amplifiers provide up to 15dB gain, with switchable FM traps. (models 0093-0096)
- Where FM is a problem, the Quantum's optional solid state FM trap attenuates interfering signals by as much as 25dB (model 0091)
- For 75 ohm mounting, use the Quantum's optional balun/matching transformer. (model 0039)

For More Details Circle (13) on Reply Card

the reading. On the HI POWER setting, about 50 ohms leakage decreases the reading to about one-half; a 2.4K leakage with the LO POWER position also halves the reading.

Base/collector leakage makes little change, but base/emitter leakage might change the polarity of the reading from one edge of the scale to the other! In that event, all three positions of the collector-locating switch will give about the same reading. This is an interesting effect; however, such defects should have been located by means of the previous tests.

### Finger Probes

Included with the instrument is a cable assembly with a 3-circuit phone plug connecting to two cables. One of the cables has three color-coded clips to grasp the leads of out-of-circuit transistors, while the other has three color-coded finger probes (Figure 3).

The finger probes evidently have been constructed from plastic guitar picks to which the probes have been fastened with epoxy.

In use, the picks are slipped over the tips of three fingers and moved about until they contact the desired points on a circuit board. A span of about 10 inches, or so, can be bridged by stretching the fingers a bit. It helps to use the other hand to place the probes, after which the sharp points tend to hold them securely. If the picks don't fit your fingers, hold them under warm running water, then bend them to a better shape.

### Other Solid-State Tests

The Wayne instruction booklet explains how to test transistors that have internal diodes between certain elements, those in direct-coupled circuits, SCR's, zeners, tunnel diodes, MOSFET's and other devices.

Tips for in-circuits tests also are given, in addition to safety suggestions.

### Summary

We tested perhaps 30 transistors using the Wayne WT2A tester, and obtained a high percentage of accurate readings.

Many of these transistors were ones previously checked by use of beta testers, curve tracers, and ohmmeter tests. They are kept in the lab for tests such as these. Except for a couple that had avalanche at certain DC collector voltages, or distortion at high or low bias, the Wayne tester discovered the defective ones. The indication of relative beta was helpful.

Perhaps the most valuable feature is the ease and accuracy of locating the base, emitter, and collector leads. For many years, I have used an ohmmeter to locate the base, and determine PNP or NPN, silicon or germanium. Unfortunately, collector and emitter test alike on an ohmmeter. In addition to collector identification, the Wayne tester offers several advantages over an ohmmeter. The color-coded leads stop most of the confusion of remembering the leads during the various tests, and the insulated clips prevent wrong readings because of leakage through the fingers.

All things considered, the Wayne WT2A solid-state tester should prove a valuable aid for either service-call or shop servicing.

### Statement of Ownership, Management and Circulation, Act of August 12, 1970; Section 3685, Title 39, United States Code.

1. Title of Publication: Electronic Servicing
2. Date of Filing: September 30, 1974
3. Frequency of issue: Monthly
4. Location of known office of publication (Street, city, county, state, zip code): 9221 Quivira Road, Shawnee Mission, Johnson County, Kansas 66215.
5. Location of the headquarters or general business offices of the publishers (not printers): 1014 Wyandotte St., Kansas City, Jackson County, Missouri 64105.
6. Names and addresses of publisher, editor, and managing editor: Publisher, Robert E. Hertel, 1014 Wyandotte St., Kansas City, Missouri 64105; Managing editor, Carl Babcoke, 1014 Wyandotte St., Kansas City, Missouri 64105.
7. Owner (if owned by a corporation, its name and address must be stated and also immediately thereunder the names and addresses of stockholders owning or holding 1 percent or more of total amount of stock. If not owned by a corporation, the names and addresses of the individual owners must be given. If owned by a partnership or other unincorporated firm, its name and address, as well as that of each individual must be given.) Howard W. Sams & Co., Inc.—a wholly owned subsidiary of International Telephone and Telegraph Corporation, 320 Park Ave., New York, New York 10022.
8. Known bondholders, mortgages, and other security holders owning or holding 1 percent or more of total amount of bonds, mortgages or other securities (If there are none, so state): None.
9. Paragraphs 7 and 8 include, in cases where the stockholders or security holder appears upon the books of the company as trustee or in any other fiduciary relation, the name of the person or corporation for whom such trustee is acting, also the statements in the two paragraphs show the affiant's full knowledge and belief as to the circumstances and conditions under which stockholders and security holders who do not appear upon the books of the company as trustees, hold stock and securities in a capacity other than that of a bona fide owner. Names and addresses of individuals who are stockholders of a corporation which itself is a stockholder or holder of bonds, mortgages or other securities of the publishing corporation have been included in paragraphs 7 and 8 when the interests of such individuals are equivalent to 1 percent or more of the total amount of the stock or securities of the publishing corporation.
10. This item must be completed for all publications except those which do not carry advertising other than the publisher's own and which are named in sections 132.231, 132.232, and 132.233, postal manual (Sections 4355a, 4355b, and 4356 of Title 39, United States Code.)

	Average No. Copies Each Issue During Preceding 12 Months	Single Issue Nearest To Filing Date
A. Total No. Copies Printed (Net Press Run)	67,083	70,933
B. Paid Circulation		
1. Sales through dealers and carriers, street vendors and counter sales	4,313	4,197
2. Mail Subscriptions	61,030	62,394
C. Total Paid Circulation	65,343	66,591
D. Free Distribution (including samples) by Mail, Carrier or Other Means	626	460
E. Total Distribution (sum of C and D)	65,969	67,051
F. Office Use, Left-Over, Unaccounted, Spoiled after Printing	1,114	3,882
G. Total (sum of E and F—should equal net press run shown in A)	67,083	70,933

I certify that the statements made by me above are correct. (Signature of editor, publisher, business manager, or owner).

ROBERT E. HERTEL

ELECTRONIC SERVICING

### ELECTRONIC SERVICING is your magazine!

If you would like to see an article about a particular subject directly related to servicing consumer or communications electronic products, send us your suggestion.

WHAT INDUSTRY IS DOING TO STOP POLLUTION

People start pollution. People can stop it.

Please send me a free copy of your guide.

Name \_\_\_\_\_  
 Street \_\_\_\_\_  
 City \_\_\_\_\_  
 State \_\_\_\_\_ Zip \_\_\_\_\_



Fig. 1 The Wayne WT2A transistor tester is shown with a small transistor plugged into one socket, and with the switches adjusted for locating the base.



Fig. 2 This closeup of the meter face shows the areas that indicate silicon or germanium material, PNP or NPN polarity, germanium leakage, relative gain, and in-circuit good/bad scale.



Fig. 3 The three finger probes have sharp tips, making it easy to penetrate insulation or corrosion, and allowing solid contacts with points on the circuits boards. One-hand operation frees the other hand to operate the switches of the tester.

red, white, and black, corresponding to the markings on the sockets and the color code of the clip leads and finger probes.

#### Step 3—C/E short test

Rotate the TEST switch to the "S" (short) position to check for C/E leakage and shorts. The previous B/E leakage test gives higher meter readings for more serious leakages. This C/E test is just the opposite: the lower the resistance reading of the leakage, the less meter deflection is obtained. For example, 50 ohms of C/E leakage on the HI POWER setting reduced the reading to one-half, while about 2.4K reduced the LO reading to one-half. B/C leakage also reduces the reading by the same amount.

A reading near zero indicates an open or shorted C/E junction, or B/C leakage. In either event, the transistor is defective.

#### Silicon or germanium? PNP or NPN?

Two other transistor characteristics are shown by the position of the meter pointer during the reading with the switch at "S": whether the material is silicon or germanium, and whether the polarity of the transistor is PNP or NPN. Near the right edge of the scale are two blue areas labelled "Si" and "Ge"; those are for NPN types. At the left edge, two similar areas show where PNP types should read. **Caution:** Excessive C/E leakage can cause a germanium type to read as though it were a silicon. And a silicon with leakage might prevent the pointer from reaching the "Si" area.

For example, a C/E leakage of 1.5K (on the LO POWER range) made a germanium read in the silicon area. And on the HI range, a leakage of 47 ohms, moved the pointer to silicon. Leakages worse than 4.7K on LO and 100 ohms on HI moved the silicon reading out of the "Si" area.

**However, the following step for balance of the B/E and B/C junctions can be used to determine germanium or silicon, even when there is a dead short between collector and emitter.**

#### Step 4—Junction balance

Alternate the TEST switch between D1 and D2 positions. The readings should be almost identical (with a non-defective transistor, the readings should be the same as the "S" position). Unequal readings indicate possible distortion in a linear amplifier stage.

At the D1 position, base/collector leakage reduces the reading, and base/emitter leakage reduces the reading on the D2 position of the TEST switch. An open element produces a zero reading. Diodes should be tested at the D2 position.

#### Silicon or germanium with leakage

If internal leakage has made identification of silicon or germanium questionable, most types can be identified correctly by noticing the readings when the TEST switch is alternated between the D1 and D2 positions. With the switch set to give the **highest** reading, the meter pointer probably will point accurately to silicon or germanium.

#### Step 5—Locating the collector

Rotate the TEST switch to the "CL" (collector-locating) position. Slide the COLLECTOR switch to each of the three positions, and leave it at the one giving the **highest** meter reading. The color listed beside that position identifies the collector lead.

#### Current gain

In addition to locating the collector lead, the test also provides a rough indication of relative current gain (when used out-of-circuit). A conversion graph is included in the instruction booklet to change the 0-50 meter scale numbers into DC beta. Silicon and germanium require different curves on the graph.

#### Leakage affects CL readings

Opens or serious leakages should have been identified before the collector-locating step. However, some peculiar meter readings can be obtained by simulating leakage. Collector-emitter leakage reduces

the reading. On the HI POWER setting, about 50 ohms leakage decreases the reading to about one-half; a 2.4K leakage with the LO POWER position also halves the reading.

Base/collector leakage makes little change, but base/emitter leakage might change the polarity of the reading from one edge of the scale to the other! In that event, all three positions of the collector-locating switch will give about the same reading. This is an interesting effect; however, such defects should have been located by means of the previous tests.

### Finger Probes

Included with the instrument is a cable assembly with a 3-circuit phone plug connecting to two cables. One of the cables has three color-coded clips to grasp the leads of out-of-circuit transistors, while the other has three color-coded finger probes (Figure 3).

The finger probes evidently have been constructed from plastic guitar picks to which the probes have been fastened with epoxy.

In use, the picks are slipped over the tips of three fingers and moved about until they contact the desired points on a circuit board. A span of about 10 inches, or so, can be bridged by stretching the fingers a bit. It helps to use the other hand to place the probes, after which the sharp points tend to hold them securely. If the picks don't fit your fingers, hold them under warm running water, then bend them to a better shape.

### Other Solid-State Tests

The Wayne instruction booklet explains how to test transistors that have internal diodes between certain elements, those in direct-coupled circuits, SCR's, zeners, tunnel diodes, MOSFET's and other devices.

Tips for in-circuits tests also are given, in addition to safety suggestions.

### Summary

We tested perhaps 30 transistors using the Wayne WT2A tester, and obtained a high percentage of accurate readings.

Many of these transistors were ones previously checked by use of beta testers, curve tracers, and ohmmeter tests. They are kept in the lab for tests such as these. Except for a couple that had avalanche at certain DC collector voltages, or distortion at high or low bias, the Wayne tester discovered the defective ones. The indication of relative beta was helpful.

**Perhaps the most valuable feature is the ease and accuracy of locating the base, emitter, and collector leads.** For many years, I have used an ohmmeter to locate the base, and determine PNP or NPN, silicon or germanium. Unfortunately, collector and emitter test alike on an ohmmeter. In addition to collector identification, the Wayne tester offers several advantages over an ohmmeter. The color-coded leads stop most of the confusion of remembering the leads during the various tests, and the insulated clips prevent wrong readings because of leakage through the fingers.

All things considered, the Wayne WT2A solid-state tester should prove a valuable aid for either service-call or shop servicing.

### Statement of Ownership, Management and Circulation, Act of August 12, 1970; Section 3685, Title 39, United States Code.

1. Title of Publication: Electronic Servicing
2. Date of Filing: September 30, 1974
3. Frequency of issue: Monthly
4. Location of known office of publication (Street, city, county, state, zip code): 9221 Quivira Road, Shawnee Mission, Johnson County, Kansas 66215.
5. Location of the headquarters or general business offices of the publishers (not printers): 1014 Wyandotte St., Kansas City, Jackson County, Missouri 64105.
6. Names and addresses of publisher, editor, and managing editor: Publisher, Robert E. Hertel, 1014 Wyandotte St., Kansas City, Missouri 64105; Managing editor, Carl Babcoke, 1014 Wyandotte St., Kansas City, Missouri 64105.
7. Owner (if owned by a corporation, its name and address must be stated and also immediately thereunder the names and addresses of stockholders owning or holding 1 percent or more of total amount of stock. If not owned by a corporation, the names and addresses of the individual owners must be given. If owned by a partnership or other unincorporated firm, its name and address, as well as that of each individual must be given.) Howard W. Sams & Co., Inc.—a wholly owned subsidiary of International Telephone and Telegraph Corporation, 320 Park Ave., New York, New York 10022.
8. Known bondholders, mortgages, and other security holders owning or holding 1 percent or more of total amount of bonds, mortgages or other securities (If there are none, so state): None.
9. Paragraphs 7 and 8 include, in cases where the stockholders or security holder appears upon the books of the company as trustee or in any other fiduciary relation, the name of the person or corporation for whom such trustee is acting, also the statements in the two paragraphs show the affiant's full knowledge and belief as to the circumstances and conditions under which stockholders and security holders who do not appear upon the books of the company as trustees, hold stock and securities in a capacity other than that of a bona fide owner. Names and addresses of individuals who are stockholders of a corporation which itself is a stockholder or holder of bonds, mortgages or other securities of the publishing corporation have been included in paragraphs 7 and 8 when the interests of such individuals are equivalent to 1 percent or more of the total amount of the stock or securities of the publishing corporation.
10. This item must be completed for all publications except those which do not carry advertising other than the publisher's own and which are named in sections 132.231, 132.232, and 132.233, postal manual (Sections 435a, 435b, and 435c of Title 39, United States Code.)

	Average No. Copies Each Issue During Preceding 12 Months	Single Issue Nearest To Filing Date
A. Total No. Copies Printed (Net Press Run)	67,083	70,933
B. Paid Circulation		
1. Sales through dealers and carriers, street vendors and counter sales	4,313	4,197
2. Mail Subscriptions	61,030	62,394
C. Total Paid Circulation	65,343	66,591
D. Free Distribution (including samples) by Mail, Carrier or Other Means	626	460
E. Total Distribution (sum of C and D)	65,969	67,051
F. Office Use, Left-Over, Unaccounted, Spoiled after Printing	1,114	3,882
G. Total (sum of E and F—should equal net press run shown in A)	67,083	70,933

I certify that the statements made by me above are correct. (Signature of editor, publisher, business manager, or owner).

ROBERT E. HERTEL

### ELECTRONIC SERVICING is your magazine!

If you would like to see an article about a particular subject directly related to servicing consumer or communications electronic products, send us your suggestion.

WHAT INDUSTRY IS DOING TO STOP POLLUTION

People start pollution. People can stop it.

Please send me a free copy of your guide.

Name \_\_\_\_\_  
 Street \_\_\_\_\_  
 City \_\_\_\_\_  
 State \_\_\_\_\_ Zip \_\_\_\_\_



# Jerrold's new Universal TV Remote Control



The Hottest New Product Since The Calculator...

- **Makes every set on your floor a remote control model**
- Universal— Attaches to any set in minutes
- Changes channel instantly and fine tunes
- Turns set on/off
- Silent push-button varactor— diode tuning— 12 channels
- Amplifies signal and eliminates direct pick up ghosts
- For homes, apartments, bars, hotels/motels, schools, hospitals and nursing homes.



*Packaged in a sturdy, colorful, self-selling carton*

## JERROLD



a GENERAL INSTRUMENT company

HEADQUARTERS & EASTERN OFFICE 200 Witmer Rd., Horsham, Penna. 19044, (215) 674-4800

SOUTHERN OFFICE 1 Perimeter Place, Suite 101, Atlanta, Georgia 30339, (404) 432-3102

WESTERN OFFICE 1255 Veterans Blvd., Redwood City, Calif. 94063, (415) 365-5050

MIDWESTERN OFFICE 1334 Atlantic Street, North Kansas City, Mo. 64116, (816) 842-1555

For More Details Circle (14) on Reply Card

# test equipment report

These features supplied by the manufacturers are listed at no-charge to them as a service to our readers.

If you want factory bulletins, circle the corresponding number on the Reply Card and mail it to us.

## Add-A-Meter

Add-A-Meter, model HVM 3900, is designed to provide continuous monitoring of the CRT anode voltage of a chassis under test without needing any additional connections. The meter, from **Telematic**, enables the technician to adjust high voltage to manufacturer's specifications, avoiding over-voltage and possible X-radiation. Self-contained, this model can be mounted anywhere as an easy add-on to any test rig. The HVM 3900 consists of a 3-1/2 inch high precision meter with self-shielded movement. Full scale reading is 35 kv with an accuracy of 2 percent.



For More Details Circle (40) on Reply Card

## Single- and Dual-Trace Scopes

Two new scopes, Model TO-55 single-trace and Model TO-60 dual-trace, are offered by **Lectrotech, Inc.**

Automatic features include astigmatism correction and automatic selection of TV vertical and horizontal triggering. Vertical sensitivity of both instruments has been increased to 10

millivolts/cm. Vertical bandwidth of the TO-55 is 10 MHz, while the dual-trace model has a 15 MHz response. All switching is done in the 1-2-5 step sequence to provide maximum resolution on all ranges.



For More Details Circle (41) on Reply Card

## Electronic Frequency Counter-Timer

**Simpson Electric Company** has announced the availability of an electronic frequency counter-timer, model 7016. The model has a frequency range of 5 Hz to 50 MHz with gate times of 10 microsecond, (0.1 kHz resolution), 0.1 second, 1.0 second, and 10 second (0.1 Hz resolution). It has a total display range of 1 to 1999999, and an accuracy of  $\pm 1$  count. A compact, lightweight unit (4 inches high, 8-1/2 inches wide, and weighing 6-1/2 pounds), 7016 is engineered for line operation and accurate readings over long periods of use.

For More Details Circle (42) on Reply Card

## High Accuracy Digital Multimeter

**Dynascan's** latest entry in the DVM field is the B&K model 282. A 3-1/2 digit model, the 282 features DC accuracy of 0.5 percent, which reportedly is 6 to 13 times greater than the accuracy of typical analog meters. The model offers automatic polarity and automatically-positioned decimal point, positive out-of-range indication, 100% overrange capability on all ranges, 1mV resolution, 10 megohms input impedance on both ACV and DCV, full overload protection on all

ranges, and 100 percent solid-state circuitry. It reads DC and AC volts, to 1000V, DC and AC current to 1000 mA, and resistance to 10 megohms. The flat display is large and non-blinking. A 3-position handle doubles as a stand for eye-level viewing at close or long range. Size of the 282 is 3-1/2X7X9 inches and the selling price is \$200.00.



For More Details Circle (43) on Reply Card

## FM Signal Generator

**Gaw Company, Incorporated** has introduced a low-cost FM signal generator, model 1012. Its features include digital frequency read-out, 8 frequency ranges, low frequency output for IF alignment, internal-external modulation, external counter to beyond 20 MHz, electronic fine tuning, double shielding, spectral purity, and less than 100 Hz residual FM.



For More Details Circle (44) on Reply Card

**FREE CATALOG**  
**HARD-TO-FIND PRECISION TOOLS**  
 Lists more than 2000 items—pliers, tweezers, wire strippers, vacuum systems, relay tools, optical equipment, tool kits and cases. Also includes ten pages of useful "Tool Tips" to aid in tool selection.

**JENSEN TOOLS**  
 4117 N. 44th Street, Phoenix, Ariz. 85018

**JENSEN TOOLS**  
 Catalog 676

For More Details Circle (18) on Reply Card

**OWN YOUR OWN PICTURE TUBE REBUILDING BUSINESS**

With Lakeside Industries rebuilding equipment you can rebuild any picture tube!

For complete details send name, address, zip code to

**LAKESIDE INDUSTRIES**  
 3520 W. Fullerton Ave.  
 Chicago, Ill. 60647  
 Phone: 312-342-3399

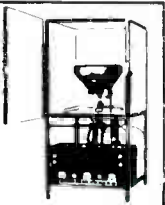

For More Details Circle (15) on Reply Card

# He's Back

Hire the  
Disabled  
Veteran

**The President's Committee  
 on Employment of the Handicapped  
 Washington, D.C. 20210**

# productreport

These features supplied by the manufacturers are listed at no-charge to them as a service to our readers. If you want factory bulletins, circle the corresponding number on the Reply Card and mail it to us.

## Double-Insulated Soldering Iron

Safe, easy-to-use, compact design, and light weight are features of the Double Insulated D-I Line from **Ungar Industrial**. The heater and handle, with a two-conductor cord set and safety plug, are double-insulated and meet the latest safety standards.

The design includes 4 stainless-steel heaters and 3 heat ranges for flexibility on the job. The handle is molded of plastic with finger-ease cool grip.

The #555 Double-Insulated 2-wire handle accepts thread-in #300 series heaters with simple-to-change heat requirements. A 45-watt integral heater with built-in iron-plated chisel tip for heavy-duty applications is also available.

More than 40 tips plus a wide selection of de-soldering accessories are available.



For More Details Circle (45) on Reply Card

## Pigtail Fuse Adapter

**Workman Electronic Products** has introduced model 33-125 adapter to convert pigtail fuses to standard 3-AG fuses. To use the adapter, connect spring ends to the lead wires, then insert fuse ends into the spring coils.

Model 33-125 is available in a package of 12, as well as a display card with 12 packages.

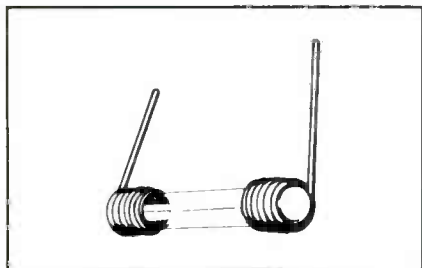

For More Details Circle (46) on Reply Card

(continued on next page)

## DELUXE HIGHWAY EMERGENCY KIT

### KIT CONTAINS:

- Carrying Case • Booster Cables • Tire Inflator • Fire Extinguisher • Emergency Blinker • Auto Spot Lite • Gas Siphon Pump • SOS Flag • First Aid Book • Complete Instruction Sheet



ONLY **\$995**

PLUS 3 TUN-O-WASH OR TUN-O-POWER LABELS

## TEXAS INSTRUMENTS 8 DIGIT, FLOATING DECIMAL CALCULATOR



ONLY **\$2495**

PLUS 5 TUN-O-WASH OR TUN-O-POWER LABELS

Get These Outstanding Values Just For Trying

# TUN-O-WASH OR TUN-O-POWER

TUN-O-POWER is the first tuner restorer. It cleans, polishes and lubricates. TUN-O-WASH is like an ultrasonic bath. It washes away all dirt, grease and gunk.

We are offering the Calculator and the Highway Emergency Kit at greatly reduced prices because we want you to try TUN-O-POWER and TUN-O-WASH. Once you do, you won't want to be without them.

To order your Calculator or Highway Emergency Kit, mail your check and labels to:



**CHEMTRONICS INCORPORATED**

1260 RALPH AVE. BROOKLYN, N.Y. 11236

Our business is improving yours.

This offer expires January 31, 1975.

For More Details Circle (16) on Reply Card

# productreport

(continued from previous page)

## Soldering Vacuum Pump

Snortini, model MV 124, from **Edsyn, Incorporated** is a pocket-sized, pencil-like, hand-operated vacuum pump designed to aid desoldering of miniature components. The small soft-action tip of the Snortini allows easy control of tool positioning with minimal recoil during the vacuum stroke. Operation and maintenance instructions are engraved on the plunger assembly. The vacuum pump is priced at \$3.95.



For More Details Circle (47) on Reply Card

## Moisture Remover

DPL, an aerosol compound that displaces moisture, lubricates, and provides a protective barrier against moisture and dirt has been introduced by **Chemtronics, Incorporated**. DPL is designed for use on all types of

electrical and electronic equipment. It prevents moisture from interfering with operation and restores operation once moisture has caused problems. For example, auto ignition systems sometimes fail after being soaked by a rain storm. Spraying DPL on a wet ignition system forces the moisture out, replacing it with a protective coating.

In addition, DPL acts as an inert lubricant for moving parts, and protects all metal against corrosion due to moisture or a salty atmosphere. It can also be used as a penetrating oil to loosen rust and to free frozen parts. It is non-conductive and will not harm plastic or rubber parts.

The price of a 4 oz. spray can is \$1.44. DPL is available in three sizes.

For More Details Circle (48) on Reply Card

## "Snap On" Home Alarm

The **Master Lock Company** is offering a line of "Snap On" Home-Alarm Sets for economical fire and burglary protection. Fast and easy installation is emphasized in the product line. There are no wires to cut, strip, solder or splice. The power source is a standard 6-volt or 12-volt battery.

Each alarm set includes a solid-state control center; an electronic super-siren with separate signals for

fire or burglary; a key switch which permits the system to be turned on or off from outside the home; intrusion detectors for doors or windows; fire detectors; 20-foot extension cords; installation manual; and identifying warning decals.

The basic set retails for \$69.95, and a deluxe version sells for \$99.50.

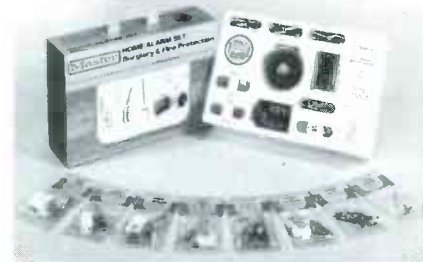

For More Details Circle (49) on Reply Card

## Five-Core Solder

**Multicore Solders** has introduced a mildly-activated rosin core solder designed for high-speed soldering of electronic assemblies. Ersin Multicore 381 RMA is said to leave a completely non-conductive and insulating flux residue, and has wetting properties nearly equal to those of Type RA (activated) core solders. Multicore 381 is available in most wire diameters in 1/2, 1, and 5 pound reels.

For More Details Circle (50) on Reply Card

# We help him make it easier for you.

Your GE tube distributor is always there when you need him. With a complete line of GE entertainment receiving tubes, replacement semiconductors and ULTRACOLOR® or all-new Spectra-Brite® picture tubes.

Competitively priced. With fast delivery assured by his balanced inventory and the GE tube warehouse network. Along with all the technical information, business and technical aids you'll ever need. You can depend on him and GE tube products.

Tube Products Department,  
General Electric Company,  
Owensboro, Kentucky 42301

# We're in this business together.

GENERAL  ELECTRIC



# The Complete Line

## FINCO® MATV CATV EQUIPMENT

- Get all your MATV-CATV needs from one reliable source.
- Free layout service.
- Send for our 120 page catalog (No. 20-554). It's FREE when requested on your company letterhead.

**THE FINNEY COMPANY**

34 W. Interstate Street, Dept. 0  
Bedford, Ohio 44146 ES-11-74

The Champion of all Independent Electronic Service

For More Details Circle (17) on Reply Card

ELECTRONIC SERVICING

(continued from page 34)

lator tube should bleed from the DC high voltage to the +400 volt source the same amount of current as drawn by the picture tube at maximum brightness. In other words, the high voltage is regulated by keeping a constant DC current drain on the HV rectifier tube. This is called DC-shunt regulation.

Control voltage for the 6BK4A is obtained from a voltage divider (R151, R154 and R16 control) connected from B-boost to ground, and the cathode goes through a 1k resistor to the +400 volt supply. In practice, the HV control is adjusted so (at maximum brightness of the picture tube) the regulator tube is barely cut off. Of course, this should not be adjusted until after the efficiency coil has been set, and any other repairs made.

Few technicians know the correct bias for 6BK4 tubes. Only about -13 or -14 volts of bias (total cathode-to-grid voltage) is enough to stop all plate current, and about -2 or -3 volts of bias causes a plate current of 1.5 milliamperes. This bias is very critical. Therefore, the usual tolerances of  $\pm 10\%$  measured from the ground are not sufficiently accurate. **Measure the bias of the 6BK4 from cathode to grid.**

#### Troubleshooting

A fast test to determine if the shunt-regulator tube is drawing excessive current is to ground the grid, thus placing about 400 volts of cutoff bias on it. If the width, focus, or amount of HV increases to normal, it's a good bet the regulator is drawing too much current.

A surprise awaited me when I grounded the grid this time, for there was a loud pop and a spark. Normally, the spark is too small to be seen. After I removed the screwdriver ground, the high voltage disappeared, and the raster was gone. I had made the situation worse!

Next, with the power off, I removed the cap of the 6BK4 and insulated it from the chassis. This time the set came on with a bright picture and no compression on the left. Evidently the regulator current was responsible for both symptoms.

While the tube was out of the socket, I measured the grid voltage and found it around 1,000 volts. C94 checked almost zero ohms.

Intermittent leakage in the capacitor had been changed into a short by the grounded-grid test. Notice that the capacitor also is a spark gap. It appears a saw was used to slit one edge during manufacturing. Always replace such capacitors with ones having a spark gap.

#### Other defects

It's advisable to measure R155 (1,000-ohm cathode resistor) in each of these receivers you service. Excessive current, perhaps from a gassy regulator tube, can overheat the resistor and cause a large change of resistance value. Some resistors have burned into two parts.

The long-term stability of R151 and R154 is very critical, because the tube bias is equally critical. Therefore, it's wise to use a replacement of higher wattage than the original, or to select a deposited-carbon type.

R214 and its connection to the video-output stage makes possible regulation that's better than perfect (at least to changes from adjustments of the brightness control). Many receivers will measure about 500 volts more of HV when the brightness control is turned up for a bright picture. Video defects and voltages have some effect on the regulation, but not enough to affect seriously any troubleshooting procedures.

#### Summary

Regardless of the type of circuit, loss of all high-voltage regulation causes the same general symptoms of picture-size changing in step with the brightness, arcs or frying sounds, plus excessive high voltage when the brightness is dim. Often these symptoms are subtle and easily overlooked. However, X-rays probably are emitted from the picture tube during dark scenes; therefore, loss of HV regulation must be taken seriously.

Too-much regulation produces such obvious symptoms as a narrow picture with poor linearity, smeared focus, or blooming. Methods were given for temporarily controlling the regulation to determine if it might be the source of the symptoms.

Keep these tips in mind, for many symptoms of regulator defects can masquerade as horizontal-sweep troubles. □

# Super quality SPRAY AIDS!



Imported line  
from famed

## KONTAKT CHEMIE

WEST GERMANY

16 formulations in handy aerosol cans that clean, protect and insulate in the repairing and service fields, and during electronic and electrical equipment production. Call or send for catalog and price information. Liberal quantity discounts.

**REGMO DATA  
CORPORATION**

"Authorized  
United  
States  
Distributors"

612/925-3800

6992 Oxford St., Mpls., MN 55426

For More Details Circle (19) on Reply Card

# audio systems report

These features supplied by the manufacturers are listed at no-charge to them as a service to our readers. If you want factory bulletins, circle the corresponding number on the Reply Card and mail it to us.

## New Features For Talk-A-Phone

Improved, and new features are now available in the **Talk-A-Phone** Chief intercommunication system which is said to have virtually a "built-in brain".

Logic and control circuits, which eliminate the manual stand-by position on the talk-listen bar are standard in the Chief. The logic circuit electronically determines when any station is busy, activates the incoming calls, signals the receiving station, places the call which the user has selected and automatically returns the unit to the stand-by position on completion of the call. It senses the line to determine whether the receiving station is private or non-private and connects the call accordingly.

Optional is the LD (Long Distance) feature, which provides for communication over miles of cable line without loss of volume. LD models can now function privately or non-privately.



For More Details Circle (51) on Reply Card

## Record-Cleaning Device

First offering in a line of record-care products from **Vor Industries** is **Vac-O-Rec**, an electric-powered, automatic-action, record-cleaning device. Dust particles in the grooves are loosened by natural-mohair brushes while the record is rotated in an electrostatic field, which attracts the dust away from the record. Any electrostatic charge remaining on the record would attract other dust, so the voltage gradually is reduced from about 20,000 volts to zero to eliminate any residual electrostatic charge.



For More Details Circle (52) on Reply Card

## Accent Speakers

Audio Accents, a product line from **Innovative Audio Systems**, consists of speakers in drum-shaped enclosures that can be hung like swag lamps anywhere an extension speaker is needed. Each speaker is supplied with 50 feet of cord to allow flexibility in placement. Six colors are available. The retail price of the speakers is \$29.95.



For More Details Circle (53) on Reply Card

## Megaphone

A new addition to the **Fanon** megaphone line is the Model MV-5S, a combination loudspeaker and warning signal system contained in a sturdy high-impact ABS plastic bell and housing and delivering five watts rated output (six watts peak power.)

The Model MV-5S features a weatherproof built-in dynamic microphone, adjustable volume control and balanced pistol grip design with trigger talk/signal switch. Power is furnished by six standard "C" batteries carried in the unit.

The MV-5S can be used in boating, sports, industry and in security applications for crowd control. The built-in signal horn alarm serves as a warning alert, starting signal, fog horn or "Mayday" call.

For More Details Circle (54) on Reply Card



## CHAPMAN

Midget RATCHET SETS  
plus ADAPTERS

Designed to function in confined space, Chapman Tools are a must for anyone who deals with small to medium size screws, bolts and nuts. Economy priced sets are available in a wide range of assortments covering Allen Hex, Metric Hex, Slotted, Phillips, Bristol and Reed and Prince sizes. Ratchet requires only 18° work arc. Screwdriver Handle and Extension included.

POCKET SIZED  
ECONOMY PRICED KITS

KIT No. 6320 only \$13.60

18°  
Working  
Arc

CATALOG  
AVAILABLE



Write! . . .

THE CHAPMAN MANUFACTURING COMPANY  
DURHAM, CONNECTICUT 06422 Dept. ES 11

For  
Better  
Results  
Use  
Reader  
Service  
Card  
In  
The  
Back  
Of  
This  
Issue

For More Details Circle (20) on Reply Card

# antenna systems report

These features supplied by the manufacturers are listed at no charge to them as a service to our readers. If you want factory bulletins, circle the corresponding number on the Reply Card and mail it to us.

## Distribution Amplifier

An extended-frequency range MATV-CATV distribution amplifier has been developed by the **AVA Electronics Corporation**. Model A-110-4 is miniature-sized, having 10 dB gain and built-in lightning protection. It may be used to compensate for the cable loss of long drops, or utilized in small multiple-dwelling installations. With a single 75-ohm input and four 75-ohm outputs, the unit also is a VHF broadband amplifier. Input either can be from TV receiving antennas, or a CATV system. Model A-110-4 is priced at \$24.90.

For More Details Circle (55) on Reply Card

## Cable Master Switch

ACA has added to their line of products the Cable Master, an easily-installed switching device that mounts on the back of the TV set, enabling the customer to choose between watching programs from the cable system, or from his own antenna. In most cases, local channels can be received with better color quality and less snow by using a good outdoor antenna instead of the cable. This difference of quality is important because about 90% of most viewing time is spent watching local channels, those best received with antennas. With the Cable Master, the customer can have both the extra channels and features of cable, plus better reception of local channels.

Model CM-10 for 300-ohm antenna lists for \$13.95, and Model CM-50 with an input for 75-ohm antenna lists for \$14.50.

For More Details Circle (56) on Reply Card



## Fringe Antenna

RCA has engineered a Permacolor

UHF/VHF-FM outdoor antenna, Model 4BG48. This type is an all-channel model that brings in deep-fringe reception of color, b-w, and FM programs. Durability is improved by solidly-riveted permanent connections of flexible aluminum between elements and feed lines. Its blue and gold plastic finish acts as a long-lasting weather protector.

Other features of the 4BG48 Permacolor antenna include special polypropylene insulators, break-off elements for FM broadcast reception control, and rugged V-shaped mast clamps. It is pre-assembled and packaged so that all elements unfold easily and lock positively into place. The antenna is constructed with a double boom for extra strength and rigidity. The product sells for \$99.95.

For More Details Circle (57) on Reply Card

## Indoor Splitters, Taps and Transformers

A complete line of indoor hybrid splitters, directional taps and transformers have been introduced by **Cerro Communication Products**. The indoor hybrid splitters are used to hook up additional sets in homes, and feature a completely-sealed housing that prevents signal leakage, 5-300 MHz bandwidth, low loss, and high isolation. Sizes range from 2- to 16-way splitters. Additional features

include rugged construction for trouble-free performance and the availability of universal mountings. The indoor directional taps also are housed in a completely-sealed enclosure, offer a flat response from 5-to 300-MHz, and are available for wallplate, raceway, and box mounting. Other features include high directivity/low loss, and compact design for easy installation. Transformers are available in two sizes. Model MTD is a heavy duty, twin-lead transformer that is cased in plated steel. Model MTS is of rugged standard weight with twin leads that comes in an aluminum casing. Both match from 75-to 300-ohm, and both have plastic sheath insulation, flat response, excellent balance (35 dB), minimum direct pick-up, and AC isolation.

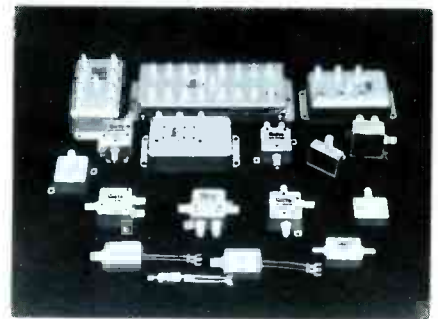

For More Details Circle (58) on Reply Card

Send  
Your  
Repair  
Tips  
To:

Electronic  
Servicing  
1014 Wyandotte  
Kansas City,  
Mo. 64105



**IF YOU MISSED IT LAST ISSUE, GET IT NOW.**

If you missed the Data Technology Model 21 insert from the last issue, or if it was ripped out before you got the magazine, just circle the reader service number below, and we'll rush you a copy.

The Model 21: It's worth reading about. A handheld portable digital multimeter that measures AC volts, and DC volts, ohms and capacitance. It's the only handheld DMM that measures capacitance.

 **data technology corporation**

2700 South Fairview Rd., Santa Ana, California 92704 • Phone (714) 546-7160

For More Details Circle (22) on Reply Card

# need belts?



## THESE 5 LITTLE BOXES PROVIDE 75% OF YOUR INVENTORY NEEDS!

Drive Belts and Wheels for over 1900 makes and models of tape recorders, dictating machines, projectors, video recorders . . . Eliminate over-stocking of interchangeable belts. Eliminate costly stock mix-ups. Use the unique, simplified PRB cross-reference system and belt-sizer. You can reduce 75% of your belt stock to five little boxes. All belt kits (drive tires, and phono idlers, too) are ready for same-day shipment on orders of one or two . . . or the full set!

**SPECIAL OFFER . . .** Free sample cassette belt of your choice (send old belt and make and model information). **FREE** catalog/cross-reference chart included. Write or call today.

### PROJECTOR RECORDER BELT CORPORATION

312 Whitewater St., Whitewater, Wis.  
53190 414/473-2151

For More Details Circle (23) on Reply Card

## FREE ALARM CATALOG

Full line of professional burglar and fire alarm systems and supplies. 96 pages, 450 items. Off the shelf delivery, quantity prices.



mountain west alarm  
4215 n. 16th st., phoenix, az. 85016

For More Details Circle (21) on Reply Card

### DISTRIBUTOR OF EUROPEAN ELECTRONIC PARTS

TELEFUNKEN • BLAUPUNKT • GRUNDIG • METZ • NORELCO • KORONETTE • PHONOSONIC • LION • KUBA • KAISER • IMPERIAL • PE • DUAL • NORMENDE AND MANY OTHERS

GERMAN ELECTRONICS SERVICE CORP.  
63-04 39th Ave P O Box 266  
Woodside, N.Y. 11377  
Tele (212) TW9-3900

For More Details Circle (24) on Reply Card

# photofact<sup>TM</sup>bulletin

PHOTOFACT BULLETIN lists new PHOTOFACT coverage issued during the last month for new TV chassis.

<b>ADMIRAL</b>	
Chassis M2408-2, M2412-2 . . . . .	1436-1
<b>BROADMOOR</b>	
2512 . . . . .	1436-2
<b>CATALINA</b>	
122-4000 . . . . .	1440-1
<b>JC PENNEY</b>	
2335A, 2338B . . . . .	1436-3
<b>JC PENNEY</b>	
4911C (855-2002), 4912C (855-2044) 4917B (855-2093), 4918B, 4924A (855-2309) . . . . .	1439-1
<b>K MART</b>	
SKP1920 . . . . .	1438-1
<b>PANASONIC</b>	
Chassis N929B . . . . .	1437-1
<b>PHILCO-FORD</b>	
Chassis 4BP24 . . . . .	1438-2
<b>RCA</b>	
Chassis CTC68AK/AN . . . . .	1437-2
<b>RCA</b>	
Chassis CTC72B/N/R . . . . .	1439-2
<b>RCA</b>	
Chassis KCS185H . . . . .	1440-2
<b>SONY</b>	
TV-760 . . . . .	1439-3
<b>TELEDYNE</b>	
3C194WL . . . . .	1440-3
<b>WARDS AIRLINE</b>	
GAI-12344A, GAI-12744a . . . . .	1437-3
<b>WARDS AIRLINE</b>	
GAI-17725A/B/C, GAI-17735A/B/C, GAI-17753A/B/C . . . . .	1438-3

birth defects  
are forever  
unless  
you help

March  
of  
Dimes

THIS SPACE CONTRIBUTED AS A PUBLIC SERVICE BY THE PUBLISHER



# bookreview

## How To Troubleshoot & Repair Electronic Test Equipment (TAB book 680)

**Author:** Mannie Horowitz

**Publisher:** Tab Books, Blue Ridge Summit, Pennsylvania 17214

**Size:** 252 pages, 143 illustrations

**Price:** \$9.95 hardbound, \$6.95 paperback

"Technician, cure your own equipment" is the watchword of this volume, written by a designer of test equipment. Therefore, author Horowitz includes in this book practical, ready-to-use data on the repair of power supplies, multimeters, oscilloscopes, audio and rf signal generators, sweep generators, and tube and semiconductor testers. No complex math or circuit theory is included. Because the theory that is presented is simplified, this book does not require study, but may be used from the very minute it's opened. Traditionally, understanding test gear has been difficult because of the maze of switching circuits that are used. In this volume, circuitry is clarified, and for each piece of equipment, there is an illustrated explanation of the basic circuits it contains. There's also a complete trouble analysis of each circuit, telling what can go wrong and what the probability of it is. Next comes an explanation of how the basic circuits are integrated into a complete circuit by the switching circuitry, and up-to-the-minute test procedures for an actual example are explained.

**Contents:** Tubes, Semiconductors, Tube and Semiconductor Defects, Switches, Power Supplies, Voltmeters, Ohmmeters, Ammeters, Troubleshooting Meter Circuits, Servicing Oscilloscopes, Servicing Audio Generators, Repairing RF Signal Generators, Sweep Generator Principles and Repairs, Tube Testers, Semiconductor Tester Operation and Repair.

## ABC'S Of Zener Diodes

**Author:** Rufus P. Turner

**Publisher:** Howard W. Sams & Co., Inc. 4300 West 62nd Street, Indianapolis, Indiana 46206

**Size:** 5 1/2 X 8 1/2 inches, 96 pages

**Price:** \$3.95 softbound

Increased use of zener diodes in the growing automotive-electronics field, plus the inclusion of zener diodes in the rapidly-developing metal-oxide-semiconductor (MOS) technology, are just two reasons for learning the "abc's" of zener diodes. Turner gives an essentials-only explanation of fundamentals such as breakdown voltage, knee of curve, reverse-leakage current and zener impedance, which are all defined clearly and concisely. Illustrative examples show how to select

a zener diode for use as a voltage regulator using an easy-to-follow, step-by-step procedure. Practical dc and ac power-supply applications are also presented. Turner includes miscellaneous applications such as a zener-switching circuit, an interstage coupling device, a zener diode as a voltage-variable capacitor, a loudspeaker protector, plus others.

**Contents:** Zener Diode Fundamentals, DC Power Supply Applications, AC Power Supply Applications, Miscellaneous Applications, Testing Zener Diodes. □

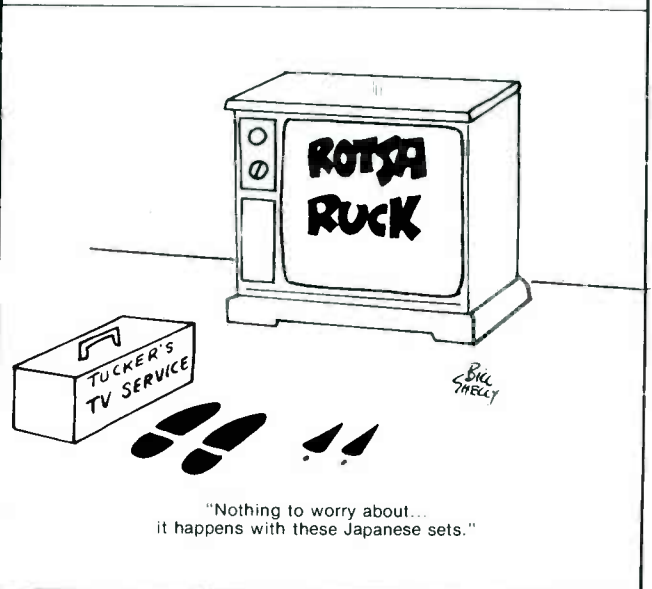

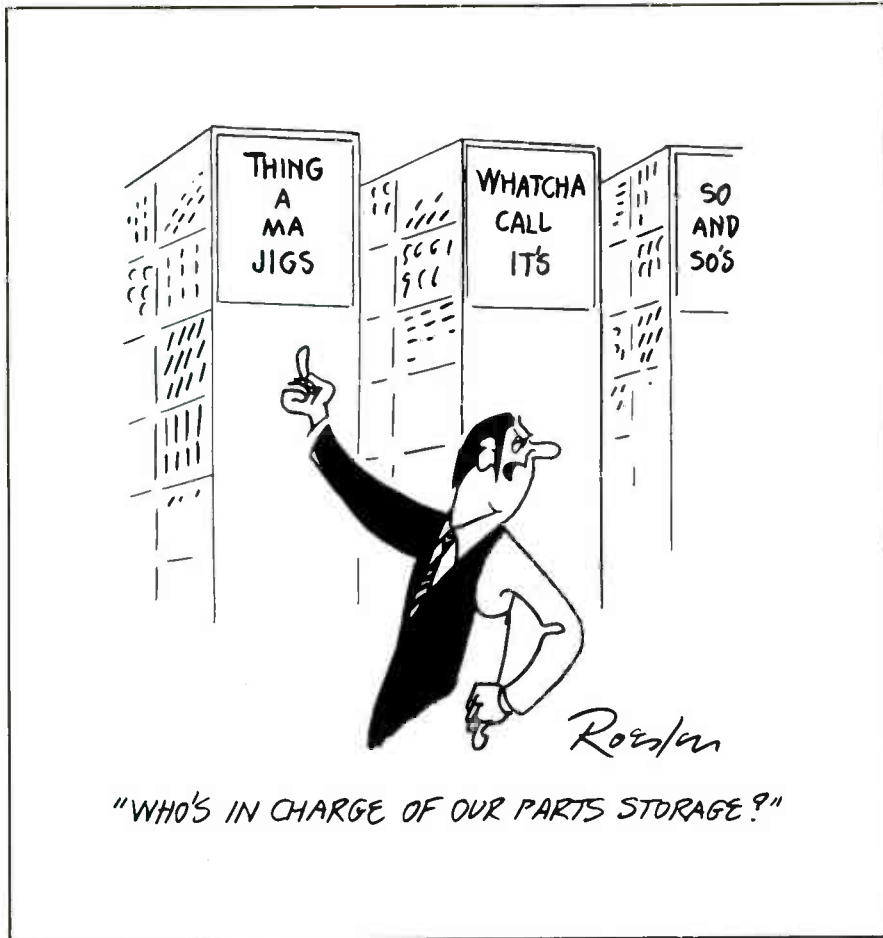

## Let us send you 33 proven ways to conserve energy in your business

We would like to tell you how Energy Management can help maintain your company's profitability. Send for your "33 Ways" booklet and we will send you something else: "How to Start an Energy Management Program."

To: U.S. Department of Commerce  
Office of Energy Programs  
Washington, D.C. 20230

Please send me your two free booklets on "33 Ways to Conserve Energy" and "How to Start An Energy Management Program."

Name \_\_\_\_\_

Title \_\_\_\_\_

Company \_\_\_\_\_

Address \_\_\_\_\_

City \_\_\_\_\_ State \_\_\_\_\_ ZIP \_\_\_\_\_

Type of Business \_\_\_\_\_

## the new automatics . . .

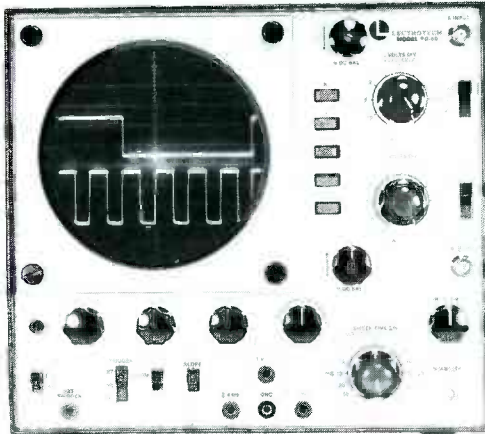

T0-60 dual-trace

T0-60 automatic dual-trace triggered sweep oscilloscope

Bandwidth: DC 15 MHz  
10 mV sensitivity **\$489.50**

T0-55 automatic single-trace triggered sweep oscilloscope

Bandwidth: DC 10 MHz  
10 mV sensitivity **\$379.50**

Made in U.S.A.

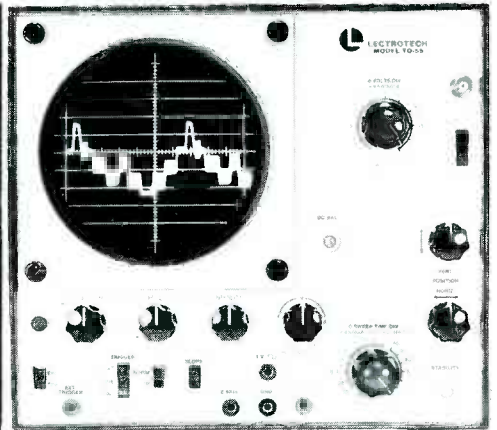

T0-55 single-trace

Two outstanding new five inch oscilloscopes with exceptional stability, featuring:

- Automatic Triggering • Automatic Astigmatism • Automatic Horizontal Sweep • Automatic TV Trigger Selection • All Switching 1-2-5 Sequence • Vertical Amplifier Sensitivity: .01 volts/div. • Horizontal Sweep Speed .2 Sec.-.5  $\mu$  Sec./div. • 5x Magnifier • All Solid State • T0-60 Dual Trace Capability: Channel "A", Channel "B", A-B Chopped, A-B Alternate, Sum of A & B.



See your distributor or write:

**LECTROTECH, INC.**

5810 N. Western Avenue, Chicago, Illinois 60659 (312) 769-6262



Available in Canada from Superior Electronics Inc.

For More Details Circle (27) on Reply Card

# catalogs literature

Circle appropriate  
number on Reader  
Service Card.

**100. Brookstone Company**—offers its second 1974 catalog of hard-to-find tools. The 60-page catalog features 76 new products in addition to the thousands of other items available from the firm.

**101. Sprague Electric Company**—has introduced a comprehensive revision of their Semiconductor Manual and Replacement Guide. The 64-page manual K-500A lists over 38,000 of the most popular domestic and foreign OEM semiconductor part numbers and their recommended replacement with 137 of Sprague's RT, TVCM, and ZT series semiconductors. All listings are alpha-numerical for simplified use of the manual. Also included is an extensive product guide section.

**102. Tab Books**—offers its 1974 catalog, describing over 300 current and forthcoming books, plus 14 electronic book/kits. Subject areas include basic electronic technology, CATV and MATV, medical electronics, radio receiver servicing, television servicing, test equipment, communications and CB radio, plus transistors and semiconductors.

**103. Telematic**—makes available their 1974 catalog of test jigs, replacement parts and service accessories. The 16-page catalog offers many new items for the service market.

**104. Mountain West Alarm Supply Company**—has announced an alarm equipment catalog, A-75. The 96-page catalog describes over 450 intrusion and fire alarm products. Equipment offered ranges from simple kits with instructions, to the latest ultrasonic, radar, and infrared intrusion detectors.

**105. RCA Electronic Components**—has released a revised product guide describing picture tubes for the renewal market. The guide, PIX-300H, includes a directory which lists replacements for 975 industry types, plus over 85 foreign types. Basing diagrams, pictorial views illustrating safety feature constructions, and keys to tube sizes in the old, new, and foreign type designation systems are covered.

**106. International Rectifier Corporation**—makes available the 1974 edition of the semiconductor cross-reference and transistor data book. The 70-page brochure lists over 44,500 parts and corresponding replacements. The parts are indexed in straight alpha-numeric sequence for easy location. Also included are transistor specifications, showing polarity, case style, maximum current, typical bandwidth and gain, and price information.

**107. Eico Electronic Instrument Company** has released a 6-page condensed catalog featuring its line of electronic test and measuring instruments. Over 100 electronic kits and factory-assembled instruments, including oscilloscopes, VTVM's, VOM's, generators, tube/transistor testers, and power supplies, are listed.

**108. Fordham Radio Supply Company**—has made available a 48-page illustrated, discount mail-order catalog, designed as a quick-reference ordering guide. Included are tools, service and repair kits, tubes, test equipment, phono cartridges and needles, speakers and microphones, antennas, components and other servicing aids. All products are shown with their discounted prices.

**109. Jensen Tools and Alloys**—offers a tool catalog with descriptions of over 2,500 items. The 112-page handbook includes sections covering tool kits, solder, technical data on tool selection, and tool "terms".

**110. Bernard Franklin Company**—announces a rack catalog which includes technical information for the bulk storage rack. The rack is intended for large items too big or

bulky for standard shelving. Models include heights to 12 feet, depths to 4 feet, and beams to 10 feet.

**111. Radio Shack**—introduces a 1975 Electronics Catalog 250, which listed hundreds of specialized electronics items, parts and accessories, tools, tubes and transistors, wire and cable, home security products, intercoms, microphones, timers, batteries, and a library of books on electronics and related subjects. The 164-page catalog has 100 full-color pages and introduces many products. □

**Have you ever  
wondered  
why the  
National Safety  
Council's logo  
is green?**



**\$** Since employees' traffic accidents cost employers one billion dollars a year in lost time and production, our color has taken on a new meaning; and if you're in business, you've probably guessed why . . . right, it's money. But more important than money is its life.

The National Safety Council can help your business save both of these. By completing your employees' training with the Defensive Driving Course you'll be saving the lives of valuable employees and gaining better employee and public relations. Your business will profit in both ways—saving lives and money. Since 85% of all traffic accidents are preventable, isn't it worth looking into.

Sponsor the National Safety Council's Defensive Driving Course . . . for a better business, all around.

# cartoon corner

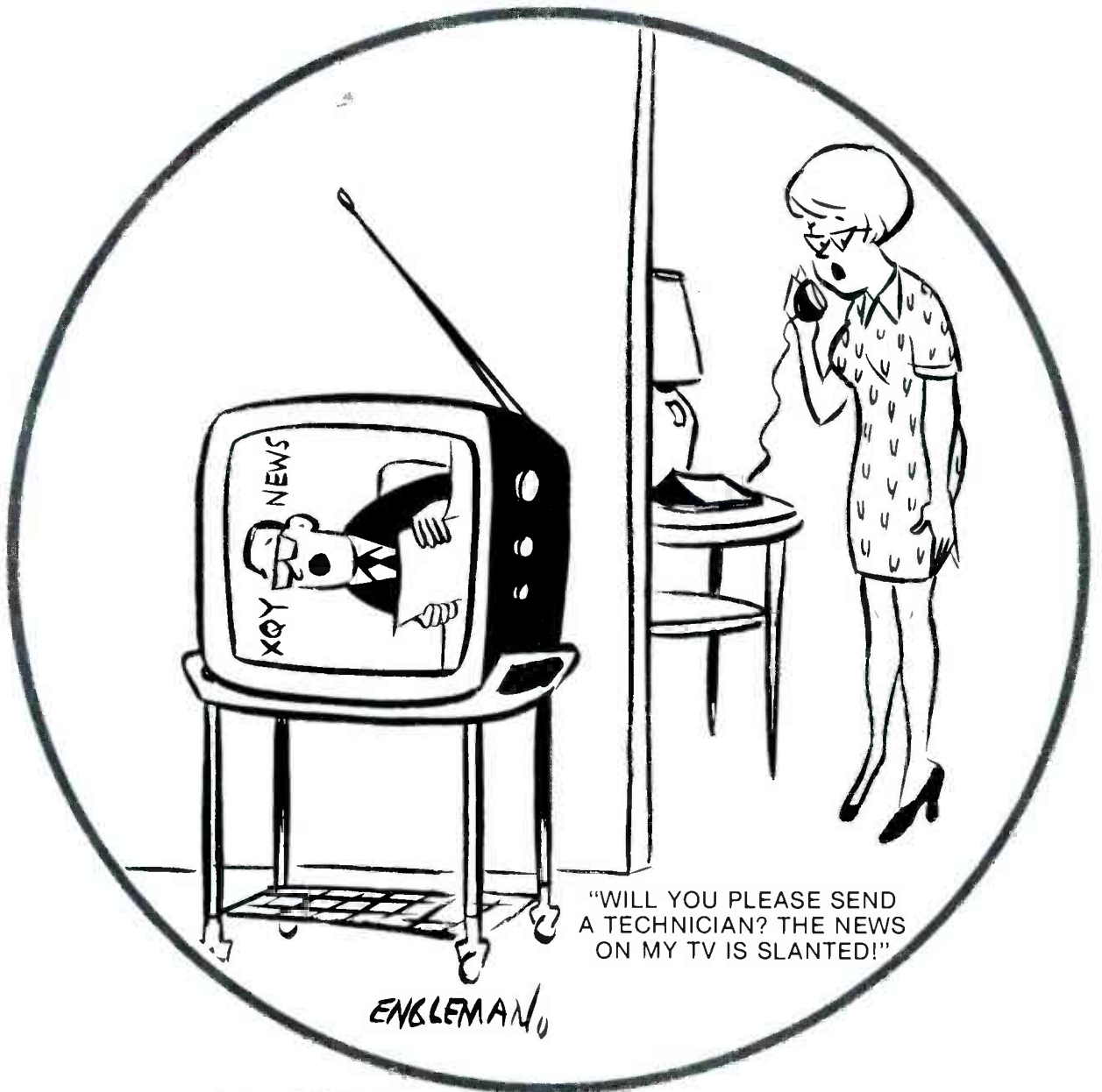

## ELECTRONICS

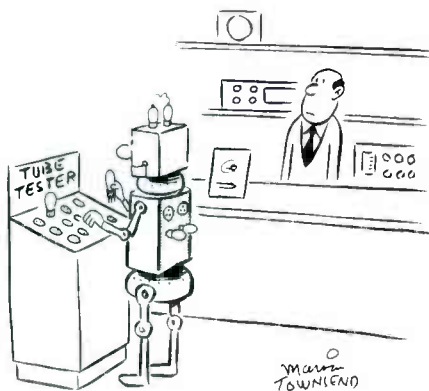

# troubleshootingtips

Send in your helpful tips—we pay!

## Blooming at low brightness RCA CTC22AA chassis (Photofact 988-2)

The TV came to the shop with the complaint of poor sharpness and continual breaker-tripping. This sort of problem usually is caused by a bad horizontal-output tube, which draws too much current. One part of the circuit breaker is in the cathode circuit of the HOT, thus causing the tripping.

Replacement of the 24JE6A output tube stopped the breaker-tripping, but another symptom appeared. Changing channels sometimes caused a decrease of high voltage, and with the service switch in the "service" position, the horizontal line was narrow and the high voltage was low.

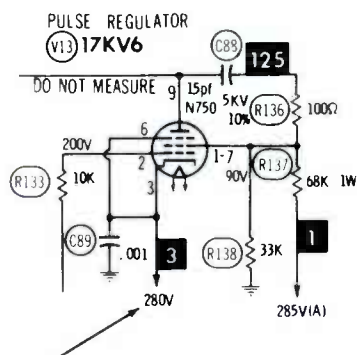

After some checking, I traced the trouble to an open in R204, a 680-ohm, 2-watt resistor in the cathode circuit of the pulse regulator tube. This part is not shown on the partial schematic, but the cathode was bypassed to ground by a 40 microfarad filter and clamped to the +280 volt supply through the resistor, which connected to the +285 supply. Also not shown are the many circuits (horizontal oscillator, AFC tube, AGC screen, sync/chroma amplifier and sync separator) obtaining power from the same cathode.

Without R204 to supply DC voltage to those other stages, the power was obtained solely by conduction of the pulses through the pulse regulator tube. However, most

of the time the cathode current was not sufficient to satisfy the requirements; therefore, the +280 voltage dropped. Notice that the +280 supply is connected to the regulator cathode, and a drop of this voltage decreased the bias, causing excessive regulator current and high-voltage blooming. This is another example of the interconnection of circuits that make logical troubleshooting more difficult. Looking back at it, a fast test would have been to ground the grid of the regulator and note any improvement which would have proved a defect in the regulator circuit.

Carl M. Colombo  
Woburn, Massachusetts

## Foldover and vertical bars Sylvania D12 (Photofact 1143-1)

The symptoms were foldover on the left side of the picture and three vertical bars near the left edge, otherwise the performance was normal.

First, I removed the horizontal oscillator tube and substituted grid drive from my Analyst. There was no improvement, so that proved the trouble was not in the horizontal-oscillator circuit.

After much searching, I found R128 had changed to 2 megohms (virtually an open circuit).

Installation of a new resistor restored the operation to normal. However, I would suggest using a 5-watt resistor as a replacement.

Richard Sanderford  
Raleigh, North Carolina

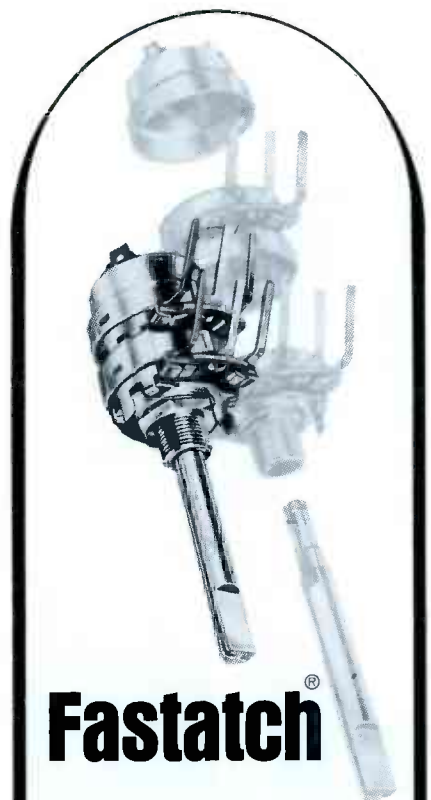
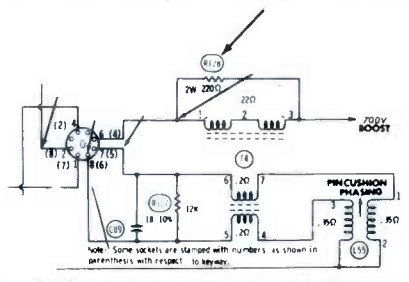

# Fastatch<sup>®</sup>

## THE RIGHT CONTROL. THE FIRST TIME.

Fastatch is Centralab's precise, complete answer to control replacement in radio, TV, stereo and auto radio. It makes possible more than 9 billion combinations — thus your Centralab Fastatch Distributor can serve you best — now. The Fastatch snap-together control exceeds OEM requirements because of these built-in features for constant service.

- Snap together, permanent locking, anti-backlash construction on dual and twin controls.
- No alignment or twisting of controls.
- Shafts can't loosen or pull out.
- No cutting of shafts.
- Universal terminals replace printed circuit, wire wrap and hole type terminals.

**WHEN YOU NEED A CONTROL  
YOUR FASTATCH DISTRIBUTOR  
IS THE FIRST MAN TO SEE**

*Get the right replacement faster  
with 8 Centralab service kits.  
See your FASTATCH  
Distributor for complete details*

DISTRIBUTOR PRODUCTS



**CENTRALAB**

Electronics Division  
GLOBE-UNION INC.

5757 NORTH GREEN BAY AVENUE  
MILWAUKEE, WISCONSIN 53201

For More Details Circle (26) on Reply Card



## The key component in this job is the professional ladder!

As a professional, your ladder gets rough and frequent use, so you need a product you can use confidently and comfortably. For your own safety, demand a professional ladder, with the ANSI Type I Heavy Duty rating: able to support your weight, plus 50 lbs. of tools and parts. Get it from your electronic parts distributor, who stocks Perma Power aluminum ladders, best for durability, strength, and safety.

Knowing the needs of electronic professionals, we've made this high quality professional ladder with the ruggedness and stability you require, yet light enough for one man handling.

A Perma Power ladder costs only a little more than the ladder you buy at the hardware store and replace every two or three years; but you'll probably never have to replace the Perma Power ladder. In fact, we unconditionally guarantee it for 12 full years!

Perma Power straight and extension ladders start from \$47.95 net. Ask your distributor, or write to Perma Power for free literature.



### Perma Power

Chamberlain Manufacturing Corporation  
Perma Power Division  
845 Larch Avenue, Elmhurst, Illinois 60126  
Telephone (312) 279-3600

For More Details Circle (29) on Reply Card

## The MARKETPLACE

This classified section is available to electronic technicians and owners or managers of service shops who have for sale surplus supplies and equipment or who are seeking employment or recruiting employees.

**Advertising Rates**  
in the Classified  
Section are:

- 25 cents per word  
(minimum \$3.00)
- "Blind" ads \$2.00  
additional
- All letters capitalized  
35 cents per word

Each ad insertion must be accompanied by a check for the full cost of the ad.

**Deadline for acceptance** is 30 days prior to the date of the issue in which the ad is to be published.

This classified section is not open to the regular paid product advertising of manufacturers.

## FOR SALE

**UNUSUAL SURPLUS AND PARTS** Catalog. \$1. ETCO Electronics Dept. E.S., Box 741, Montreal "A" H3C 2V2 12-73-121

**NEW Canadian Magazine "Electronics Workshop"**. \$5.00 yearly. Sample \$1.00. Ethko, Box 741, Montreal "A" Canada. 10-74-121

**"SUPER SIG" CB Base Antenna**. You build yourself in one hour. Simple Plans \$1.00. TIPS, Box 188, Bruce, Miss. 38915. 10-74-21

**TV GONE OUT??** It may — this is football season you know. Don't risk it. We'll show you how to repair your own. Simple instructions \$1.00. TIPS, Box 188, Bruce, Miss. 38915. 10-74-21

**TEST color CRT's with B/W CRT tester**. Instructions \$1. TIPS, Box 188, Bruce, Miss. 38915. 10-74-21

**BUILD tuner subber from junk TV**. Plans \$1. TIPS, Box 188, Bruce, Miss. 38915. 10-74-21

**TV & RADIO TUBES 36c EA!** Free color catalog. Cornell, 4221 University, San Diego, California 92105. 10-74-61

**DYNACO-A-R-TRANSISTORS, REPAIR BOARDS & UNITS, SPEAKER SERVICE. SEND FOR PRICES AND DETAILS: BEAR ELECTRONICS-177-E-HILLCREST ROAD, MT. VERNON, N.Y. 10552.** 10-74-21

**STOCK OF TV TUBES**, parts and Sams Photo-facts. Salto TV, Sparta, Illinois 62286. 618-443-3734 11-74-11

**EVERYTHING** you always wanted to know about service contracts, but didn't know who to ask. "THE SERVICE CONTRACT COOKBOOK" only \$15.00 postpaid when you ask NATESA, Dept SC, 5908 S. Troy, Chicago, Ill., 60629. 11-74-11

**FREQUENCY COUNTER** Heath-Schlumberger SM-128A, Cost \$357.00 new. Never used. Will sacrifice at \$195.00. Write P.O. Box 406, Hawthorne, N.J. 07506. 11-74-11

## FOR SALE CONT'D

**"MONSANTO Model 1515A Counter-Timer**, Model 1103A Freq. Conv. Plug-in. Freq. DC to 500MHZ. Factory carton. On for one hour. Over \$2,000 value. First \$1000 plus shipping takes it. Arthur Couture, Rt. 2, Box 104-B, Blountsville, Al. 35031. 11-74-11

## EDUCATION-INSTRUCTION

**REPAIR TV TUNERS**—High Earnings; Complete Course Details, 12 Repair Tricks, Many Plans, Two Lessons, all for \$2. Refundable. Frank Bocek, Box 3236 Enterprise, Redding, Calif. 96001. 6-74-61

**NOW! Master Solid State Vertical Oscillator-Output Circuit problems**. Latest instruction teaches current circuitry. \$1 brings lesson, details. Reidel, Box 9603, Denver, Colorado 80209. 7-74-11

**FREE catalog 250 low cost self improvement books**. Bonat, 67 Theodore Street, Buffalo, New York 14211. 11-74-11

## advertisers' index

Appleway Electronics, Inc	57
B & K Div., Dynascan Corp.	3
Bussmann Mfg. Div.,	
McGraw-Edison	37
Castle TV	
Tuner Service	59, Cover 4
Centralab Globe-Union, Inc.	55
Channel Master	38-39
Chapman Manufacturing	48
Chemtronics Incorporated	45
Cleveland Institute of Electronics	57
Data Technology Corporation	49
The Finney Company	46
Gem City Tuner	10
General Electric Company	9, 46
German Electronics	
Service Corporation	50
Heath Company	17-18, 19
Jensen Tools and Alloys	44
Jerrold Electronics	43
Lakeside Industries	44
Lectrotech, Inc.	52
Mountain West Alarm Supply Co.	50
Oneida Electronic Mfg., Inc.	7
Perma Power	56
Platt Luggage	59
Pomona Electronics	25
Precision Tuner Service	57, Cover 2
Projector-Recorder Belt Co.	50
Regmo Data Corporation	47
Rohn Manufacturing	7
Sperry Tech, Inc.	16
Sprague Products Co.	11, 59
GTE Sylvania -	
Consumer Renewal	1, Cover 3
Telematic	16
Tuner Service Corporation	5

# Now you can get "XR" glass tubes in our economy line.

You know the EIA guidelines. Replace like with like.

That used to mean that all you could offer in "XR" glass tubes were the all-new, more expensive types.

Now, Sylvania has changed all that.

We've added 19 of the "XR" glass types to our Color Screen 85 economy line, and another 5 types to our medium price Color Bright 85® RE line. You can tell them by the

"V" designation in the type number. For example 23 VANP22. And of course, you've got all types in our Color Bright 85® "XR" new tube replacement line.

Three lines to offer. Three prices to offer.

That should eliminate a lot of your customer's inhibitions.

Electronic Components Group, GTE Sylvania, 100 First Avenue, Waltham, Mass. 02154.

Another first from the leader

**GTE SYLVANIA**



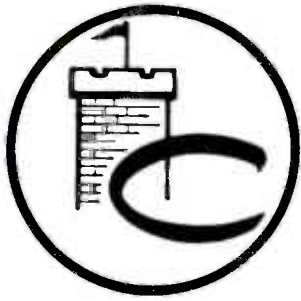

# The Tuner People

*Pioneers of TV Tuner Overhauling  
Originators of Complete TV Tuner Service*

*Castle offers the following services to solve ALL your television tuner problems.*

## Universal Replacements from \$8.95

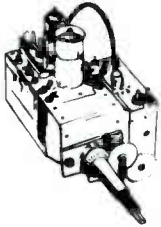

These universal replacement tuners are all equipped with memory fine tuning and uhf position with plug input for uhf tuner. They come complete with hardware and component kit to adapt for use in thousands of popular TV receivers.

STOCK No.	HEATERS	SHAFT		I.F. Snd.	PRICE
		Min.*	Max.*		
CR6P	Parallel 6.3v	1¾"	3"	41.25	8.95
CR7S	Series 600mA	1¾"	3"	41.25	9.50
CR9S	Series 450mA	1¾"	3"	41.25	9.50
CR6XL	Parallel 6.3v	2½"	12"	41.25	10.45
CR7XL	Series 600mA	2½"	12"	41.25	11.00
CR9XL	Series 450mA	2½"	12"	41.25	11.00

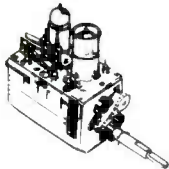
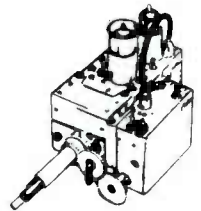

## Castle Replacements

**\$15.95**

Castle custom replacements made to fit in place of original tuner. Purchase outright . . . no exchange needed. Write for current list of Castle replacements, or request the part number you require (use number on ORIGINAL TUNER ONLY; do not use service literature numbers). Available for many of the popular models of following manufacturers: Admiral, Curtis Mathes, Emerson, GE, Heathkit, Magnavox, Motorola, Muntz, Philco, RCA, Sears, Sylvania, Westinghouse, Zenith and many private labels.

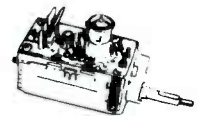

## Overhaul Service

**\$9.95**

*This is the service pioneered by Castle! We are now in our third decade of serving the TV Service Industry*

Service on all makes and models, vhf or uhf, including transistor and color tuners . . . one price \$9.95 Overhaul includes parts, except tubes and transistors.

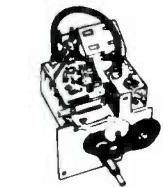

**Remember!**

Castle overhaul service is as near as your post office

Simply send us the defective tuner complete; include tubes, shield cover and any damaged parts with model number and complaint. Your tuner will be expertly overhauled and returned promptly, performance restored, aligned to original standards and warranted for 90 days.

Dismantle tandem uhf and vhf tuners and send in defective unit only. Remove all accessories . . . or dismantling charge will apply.

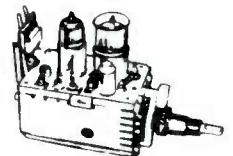

## Custom Exchange Service

**\$17.95**

When our inspection reveals that original tuner is unfit for overhaul, and it is not available from our stock of outright replacements, we offer to make a custom replacement on exchange basis. Charge for this service is \$15.95 for uhf tuner and \$17.95 for vhf tuner.

If custom replacement cannot be made we will custom rebuild the original tuner at the exchange replacement price.

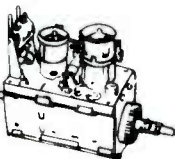
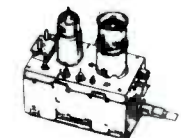

All replacements are new or rebuilt. All prices are f.o.b. our plant. Add shipping and handling of \$1.25 on all prepaid orders. We will ship C.O.D.

**CASTLE TV TUNER SERVICE, INC.**

5701 N. Western Ave., Chicago, Ill. 60645 • Ph. 312-561-6354

For More Details Circle (3) on Reply Card